

**Pioneer**

**DJ MIXER**

**DJM-900NXS**

**DJM-900nexus**

**<http://www.prodjnet.com/support/>**

The Pioneer website shown above offers FAQs, information on software and various other types of information and services to allow you to use your product in greater comfort.

**Operating Instructions**

Thank you for buying this Pioneer product. Please read through these operating instructions so you will know how to operate your model properly. After you have finished reading the instructions, put them away in a safe place for future reference.

In some countries or regions, the shape of the power plug and power outlet may sometimes differ from that shown in the explanatory drawings. However the method of connecting and operating the unit is the same.

## IMPORTANT



The lightning flash with arrowhead symbol, within an equilateral triangle, is intended to alert the user to the presence of uninsulated "dangerous voltage" within the product's enclosure that may be of sufficient magnitude to constitute a risk of electric shock to persons.

### CAUTION

**RISK OF ELECTRIC SHOCK  
DO NOT OPEN**



**CAUTION:**  
TO PREVENT THE RISK OF ELECTRIC SHOCK, DO NOT REMOVE COVER (OR BACK). NO USER-SERVICEABLE PARTS INSIDE. REFER SERVICING TO QUALIFIED SERVICE PERSONNEL.

The exclamation point within an equilateral triangle is intended to alert the user to the presence of important operating and maintenance (servicing) instructions in the literature accompanying the appliance.

D3-4-2-1-1\_A1\_En

## IMPORTANT SAFETY INSTRUCTIONS

- 1) Read these instructions.
- 2) Keep these instructions.
- 3) Heed all warnings.
- 4) Follow all instructions.
- 5) Do not use this apparatus near water.
- 6) Clean only with dry cloth.
- 7) Do not block any ventilation openings. Install in accordance with the manufacturer's instructions.
- 8) Do not install near any heat sources such as radiators, heat registers, stoves, or other apparatus (including amplifiers) that produce heat.
- 9) Do not defeat the safety purpose of the polarized or grounding-type plug. A polarized plug has two blades with one wider than the other. A grounding type plug has two blades and a third grounding prong. The wide blade or the third prong are provided for your safety. If the provided plug does not fit into your outlet, consult an electrician for replacement of the obsolete outlet.
- 10) Protect the power cord from being walked on or pinched particularly at plugs, convenience receptacles, and the point where they exit from the apparatus.
- 11) Only use attachments/accessories specified by the manufacturer.
- 12) Use only with the cart, stand, tripod, bracket, or table specified by the manufacturer, or sold with the apparatus. When a cart is used, use caution when moving the cart/apparatus combination to avoid injury from tip-over.
- 13) Unplug this apparatus during lightning storms or when unused for long periods of time.
- 14) Refer all servicing to qualified service personnel. Servicing is required when the apparatus has been damaged in any way, such as power-supply cord or plug is damaged, liquid has been spilled or objects have fallen into the apparatus, the apparatus has been exposed to rain or moisture, does not operate normally, or has been dropped.



D3-7-13-69\_En

### NOTE:

This equipment has been tested and found to comply with the limits for a Class B digital device, pursuant to Part 15 of the FCC Rules. These limits are designed to provide reasonable protection against harmful interference in a residential installation. This equipment generates, uses, and can radiate radio frequency energy and, if not installed and used in accordance with the instructions, may cause harmful interference to radio communications. However, there is no guarantee that interference will not occur in a particular installation. If this equipment does cause harmful interference to radio or television reception, which can be determined by turning the equipment off and on, the user is encouraged to try to correct the interference by one or more of the following measures:

- Reorient or relocate the receiving antenna.
- Increase the separation between the equipment and receiver.
- Connect the equipment into an outlet on a circuit different from that to which the receiver is connected.
- Consult the dealer or an experienced radio/TV technician for help.

D8-10-1-2\_A1\_En

### FEDERAL COMMUNICATIONS COMMISSION DECLARATION OF CONFORMITY

This device complies with part 15 of the FCC Rules. Operation is subject to the following two conditions: (1) This device may not cause harmful interference, and (2) this device must accept any interference received, including interference that may cause undesired operation.

Product Name: DJ MIXER  
Model Number: DJM-900NXS  
Responsible Party Name: PIONEER ELECTRONICS (USA) INC.  
SERVICE SUPPORT DIVISION  
Address: 1925 E. DOMINGUEZ ST. LONG BEACH, CA 90810-1003, U.S.A.  
Phone: 1-800-421-1404  
URL: <http://www.pioneerelectronics.com>

D8-10-4\*\_C1\_En

## WARNING

This equipment is not waterproof. To prevent a fire or shock hazard, do not place any container filled with liquid near this equipment (such as a vase or flower pot) or expose it to dripping, splashing, rain or moisture.

D3-4-2-1-3\_A1\_En

## WARNING

*Before plugging in for the first time, read the following section carefully.*

**The voltage of the available power supply differs according to country or region. Be sure that the power supply voltage of the area where this unit will be used meets the required voltage (e.g., 230 V or 120 V) written on the side panel.**

D3-4-2-1-4\*\_A1\_En

## WARNING

This product equipped with a three-wire grounding (earthed) plug - a plug that has a third (grounding) pin. This plug only fits a grounding-type power outlet. If you are unable to insert the plug into an outlet, contact a licensed electrician to replace the outlet with a properly grounded one. Do not defeat the safety purpose of the grounding plug.

D3-4-2-1-6\_A1\_En

## WARNING

To prevent a fire hazard, do not place any naked flame sources (such as a lighted candle) on the equipment.

D3-4-2-1-7a\_A1\_En

## VENTILATION CAUTION

When installing this unit, make sure to leave space around the unit for ventilation to improve heat radiation (at least 5 cm at rear, and 3 cm at each side).

## WARNING

Slots and openings in the cabinet are provided for ventilation to ensure reliable operation of the product, and to protect it from overheating. To prevent fire hazard, the openings should never be blocked or covered with items (such as newspapers, table-cloths, curtains) or by operating the equipment on thick carpet or a bed.

D3-4-2-1-7b\*\_A1\_En

## Operating Environment

Operating environment temperature and humidity: +5 °C to +35 °C (+41 °F to +95 °F); less than 85 %RH (cooling vents not blocked)

Do not install this unit in a poorly ventilated area, or in locations exposed to high humidity or direct sunlight (or strong artificial light)

D3-4-2-1-7c\*\_A1\_En

If the AC plug of this unit does not match the AC outlet you want to use, the plug must be removed and appropriate one fitted. Replacement and mounting of an AC plug on the power supply cord of this unit should be performed only by qualified service personnel. If connected to an AC outlet, the cut-off plug can cause severe electrical shock. Make sure it is properly disposed of after removal. The equipment should be disconnected by removing the mains plug from the wall socket when left unused for a long period of time (for example, when on vacation).

D3-4-2-2-1a\_A1\_En

## CAUTION

The **POWER** switch on this unit will not completely shut off all power from the AC outlet. Since the power cord serves as the main disconnect device for the unit, you will need to unplug it from the AC outlet to shut down all power. Therefore, make sure the unit has been installed so that the power cord can be easily unplugged from the AC outlet in case of an accident. To avoid fire hazard, the power cord should also be unplugged from the AC outlet when left unused for a long period of time (for example, when on vacation).

D3-4-2-2-2a\*\_A1\_En

## IMPORTANT NOTICE

THE MODEL NUMBER AND SERIAL NUMBER OF THIS EQUIPMENT ARE ON THE RIGHT SIDE. RECORD THESE NUMBERS ON PAGE 27 FOR FUTURE REFERENCE.

D36-AP9-1\_A1\_En\_P5V

**WARNING:** Handling the cord on this product or cords associated with accessories sold with the product may expose you to chemicals listed on proposition 65 known to the State of California and other governmental entities to cause cancer and birth defect or other reproductive harm.

**Wash hands after handling.**

D36-P5\_B1\_En

## Information to User

Alterations or modifications carried out without appropriate authorization may invalidate the user's right to operate the equipment.

D8-10-2\_A1\_En

This Class B digital apparatus complies with Canadian ICES-003.

D8-10-1-3\_A1\_En

## CAUTION

This product satisfies FCC regulations when shielded cables and connectors are used to connect the unit to other equipment. To prevent electromagnetic interference with electric appliances such as radios and televisions, use shielded cables and connectors for connections.

D8-10-3a\_A1\_En

## POWER-CORD CAUTION

Handle the power cord by the plug. Do not pull out the plug by tugging the cord and never touch the power cord when your hands are wet as this could cause a short circuit or electric shock. Do not place the unit, a piece of furniture, etc., on the power cord, or pinch the cord. Never make a knot in the cord or tie it with other cords. The power cords should be routed such that they are not likely to be stepped on. A damaged power cord can cause a fire or give you an electrical shock. Check the power cord once in a while. When you find it damaged, ask your nearest PIONEER authorized service center or your dealer for a replacement.

S002\*\_A1\_En

## **The Safety of Your Ears is in Your Hands**

Get the most out of your equipment by playing it at a safe level – a level that lets the sound come through clearly without annoying blaring or distortion and, most importantly, without affecting your sensitive hearing. Sound can be deceiving. Over time, your hearing “comfort level” adapts to higher volumes of sound, so what sounds “normal” can actually be loud and harmful to your hearing. Guard against this by setting your equipment at a safe level BEFORE your hearing adapts.

### **ESTABLISH A SAFE LEVEL:**

- Set your volume control at a low setting.
- Slowly increase the sound until you can hear it comfortably and clearly, without distortion.
- Once you have established a comfortable sound level, set the dial and leave it there.

### **BE SURE TO OBSERVE THE FOLLOWING GUIDELINES:**

- Do not turn up the volume so high that you can't hear what's around you.
- Use caution or temporarily discontinue use in potentially hazardous situations.
- Do not use headphones while operating a motorized vehicle; the use of headphones may create a traffic hazard and is illegal in many areas.

S001a\_A1\_En

---

---

# Contents

## How to read this manual

The names of displays, menus, and buttons in this manual are enclosed in brackets. (e.g. [MASTER] channel, [ON/OFF], [File] menu)

### 01 Before start

Features .....	6
What's in the box.....	6

### 02 Connections

Rear panel.....	7
Connecting input terminals.....	8
Connecting output terminals.....	8
Connecting to the control panel .....	9
About the driver software and setting utility software .....	9

### 03 Operations

Control Panel.....	12
Basic Operation .....	14
Advanced Operations .....	15

### 04 Types of effects

Types of SOUND COLOR FX effects .....	18
Types of BEAT EFFECT .....	18

### 05 List of MIDI Messages

### 06 Changing the settings

About the auto standby function .....	23
About the talk over function.....	23
Setting preferences.....	23

### 07 Additional information

Troubleshooting .....	24
Block Diagram.....	25
Disclaimer.....	26
Specifications.....	26

---

---

# Before start

---

---

## Features

This unit is a standard type DJ mixer for professional DJs that carries over the technology of the Pioneer DJM series, the world standard in club sound. Not only is it equipped with a wide variety of functions for DJ performances, including PRO DJ LINK, SOUND COLOR FX and BEAT EFFECT, it also uses a high sound quality design and a panel layout with high operability to provide strong support for performances to all professional DJs active in the club scene.

---

---

## SOUND CARD

This unit is equipped with "sound card/USB audio interface".

- Up to 4 sets of audio signals from a single computer can be assigned to the different channels and mixed.
- DVS (Digital Vinyl System) software time code signals played from a DJ player or analog player can be output to the user's DVS software. This enables DJ play using DVS software without all the complicated connections.
- Up to 4 sets of audio signals from the different channels (channels 1 to 4, REC OUT, crossfader sides A and B and microphone) can be output to the computer. This is very convenient for recording the mixed sound.

---

---

## HIGH SOUND QUALITY

Efforts have been made for improved sound quality in the digital/analog inputs/outputs. Sound processing with 96 kHz sampling, a 24-bit high sound quality A/D converter and a 32-bit high sound quality D/A converter result in more powerful, high grade sound.

96 kHz 24-bit USB audio is supported.

---

---

## SOUND COLOR FX

This unit is equipped with 6 types of effects. Effects can be obtained simply by turning the [COLOR] controls provided for each of the channels, letting DJs adjust the sound quality of the tracks input to the different channels and make improvisational performances.

---

---

## BEAT EFFECT

The BEAT EFFECT function well-received on the DJM series is carried over and further evolved.

This unit has been newly equipped with an [X-PAD] for achieving various effects by touch operation, allowing you to achieve intuitive live performances with great freedom.

---

---

## CHANNEL FADER

A newly developed high reliability fader is used for the channel fader.

Compared to channel faders on previous models in the DJM series, this new fader offers improved endurance with respect to deterioration due to dust, liquids, etc., getting on the fader. Smooth operation is maintained even under tough usage conditions.

---

---

## PRO DJ LINK

The PRO DJ LINK functions can be used when a Pioneer DJ player supporting PRO DJ LINK (CDJ-2000, CDJ-900 etc.), a computer on which rekordbox is installed and this unit are connected by LAN cable.

For details on PRO DJ LINK, see *About PRO DJ LINK* on page 15.

---

---

## STANDARD LAYOUT

This unit carries over the control panel layout of the Pioneer DJM series, the world standard in DJ mixers.

The simple, straightforward control panel layout not only facilitates DJ performances but lets even DJs using this unit for the first time to operate it without hesitation, so it can be used without worry as a mixer that is permanently installed in the club.

---

---

## What's in the box

- CD-ROM
- USB cable
- Power cord
- Operating instructions (this document)

# Connections

Be sure to turn off the power and unplug the power cord from the power outlet whenever making or changing connections. Refer to the operating instructions for the component to be connected. Connect the power cord after all the connections between devices have been completed. Be sure to use the included power cord.

## Rear panel

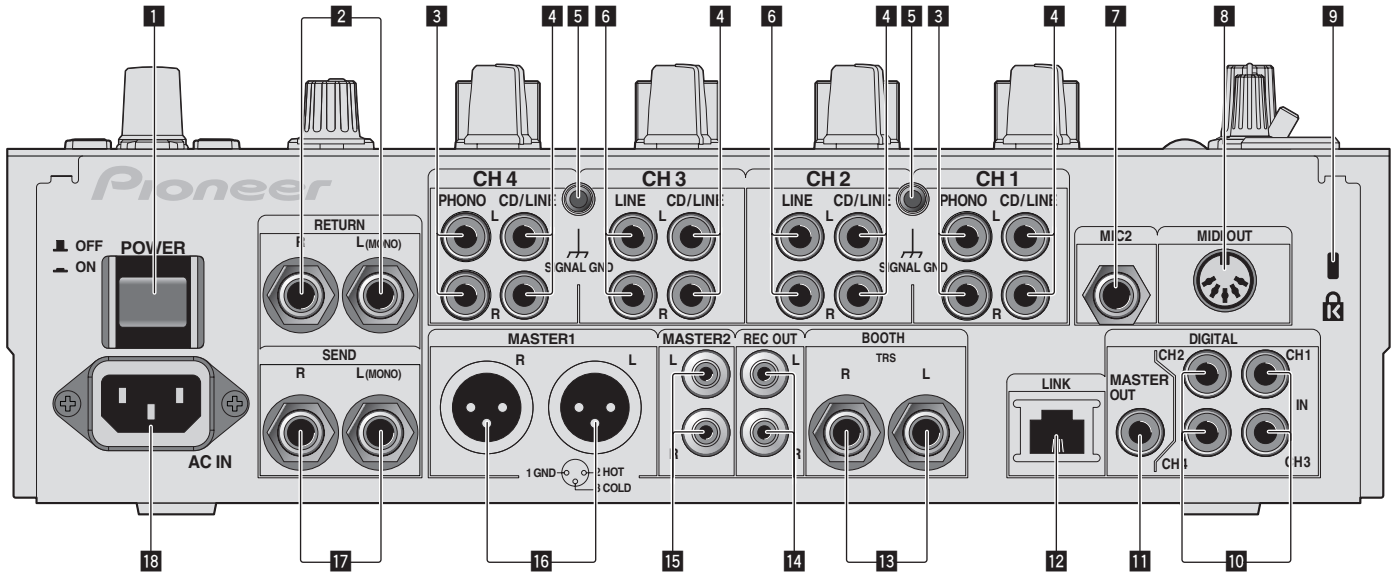

### 1 POWER button (page 14)

Turns this unit's power on and off.

### 2 RETURN terminals (page 8)

Connect to the output terminal of an external effector. When the [L (MONO)] channel only is connected, the [L (MONO)] channel input is simultaneously input to the [R] channel.

### 3 PHONO terminals (page 8)

Connect to a phono level (MM cartridge) output device. Do not input line level signals. To connect a device to the [PHONO] terminals, remove the short-circuit pin plug inserted in the terminals. Insert this short-circuit pin plug into the [PHONO] terminals when nothing is connected to them to cut external noise.

### 4 CD/LINE terminals (page 8)

Connect to a DJ player or a line level output component.

### 5 SIGNAL GND terminal (page 8)

Connect an analog player's ground wire here. This helps reduce noise when the analog player is connected.

### 6 LINE terminals (page 8)

Connect to a cassette deck or a line level output component.

### 7 MIC2 terminal (page 8)

Connect a microphone here.

### 8 MIDI OUT terminal (page 8)

Connect this to the MIDI IN terminal on an external MIDI sequencer.

### 9 Kensington security slot

### 10 DIGITAL IN terminal (page 8)

Connect these to the digital coaxial output terminals on DJ players, etc. The sound may be momentarily interrupted when the output signal sampling frequency is switched.

### 11 DIGITAL MASTER OUT terminals (page 8)

Outputs the master channel audio signals.

### 12 LINK terminal (page 8)

Connect these to the LINK terminals on Pioneer DJ players or the LAN ports of computers on which rekordbox is installed (PRO DJ LINK). To connect multiple devices, use a switching hub (commercially available). Use a 100Base-TX-compatible switching hub. Some switching hubs may not operate properly.

### 13 BOOTH terminals (page 8)

Output terminals for a booth monitor, compatible with balanced or unbalanced output for a TRS connector.

### 14 REC OUT terminals (page 8)

This is an output terminal for recording.

### 15 MASTER2 terminals (page 8)

Connect to a power amplifier, etc.

### 16 MASTER1 terminals (page 8)

Connect to a power amplifier, etc.

### 17 SEND terminals (page 8)

Connect to the input terminal of an external effector. When the [L (MONO)] channel only is connected, a monaural audio signal is output.

### 18 AC IN

Connect to a power outlet using the included power cord. Wait until all connections between the equipment are completed before connecting the power cord. Be sure to use the included power cord.

### WARNING

The short-circuit pin plugs out of the reach of children and infants. If accidentally swallowed, contact a doctor immediately.

## Connecting input terminals

- When creating a DVS (Digital Vinyl System) combining a computer, audio interface, etc., be careful in connecting the audio interface to this unit's input terminals and in the settings of the input selector switches. Also refer to the operating instructions of the DJ software and audio interface.

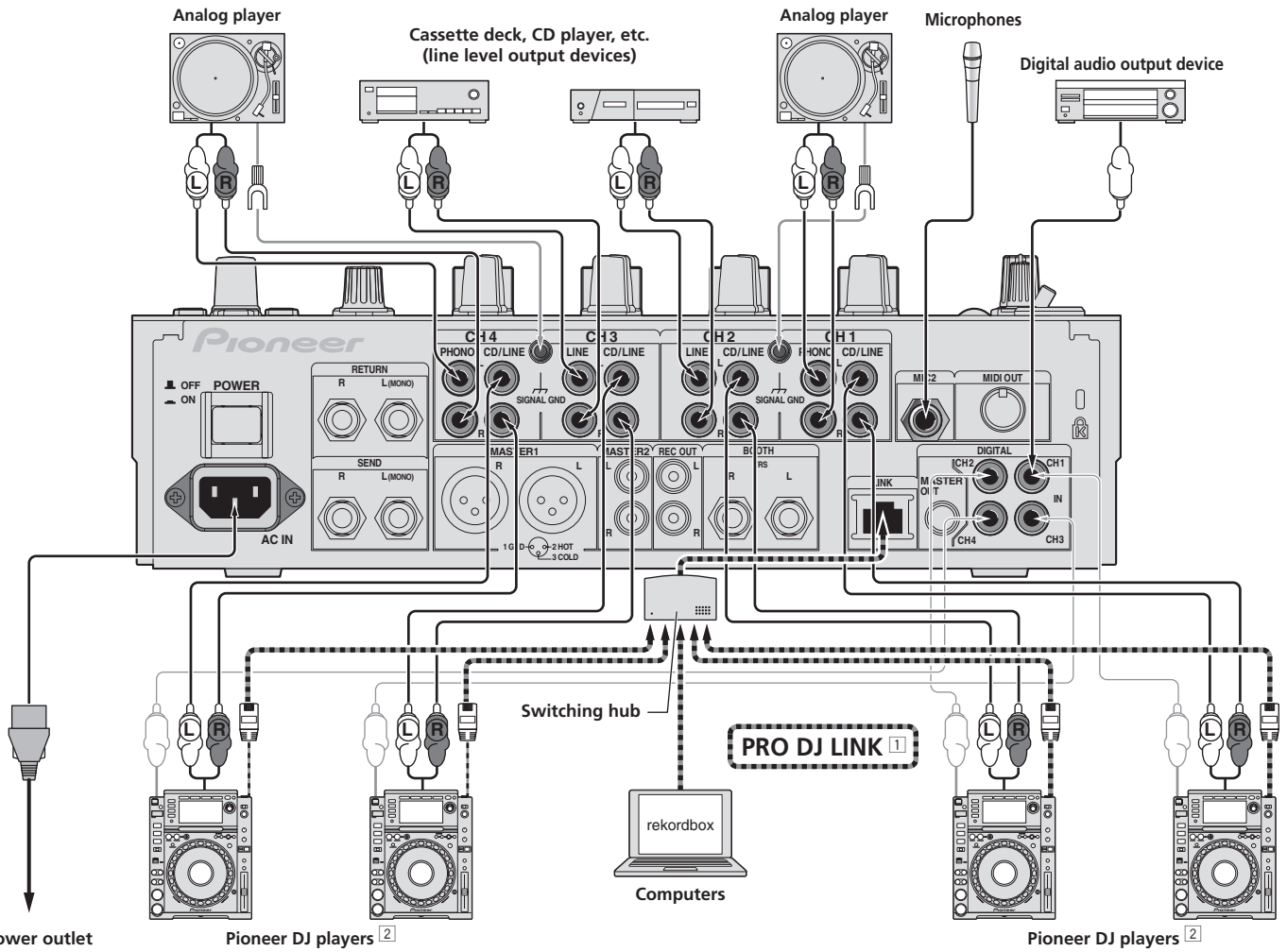

To power outlet

Pioneer DJ players <sup>2</sup>

Pioneer DJ players <sup>2</sup>

<sup>1</sup> For details on PRO DJ LINK, see *About PRO DJ LINK* on page 15.

<sup>2</sup> To use the fader start function, connect a LAN cable (page 14).

## Connecting output terminals

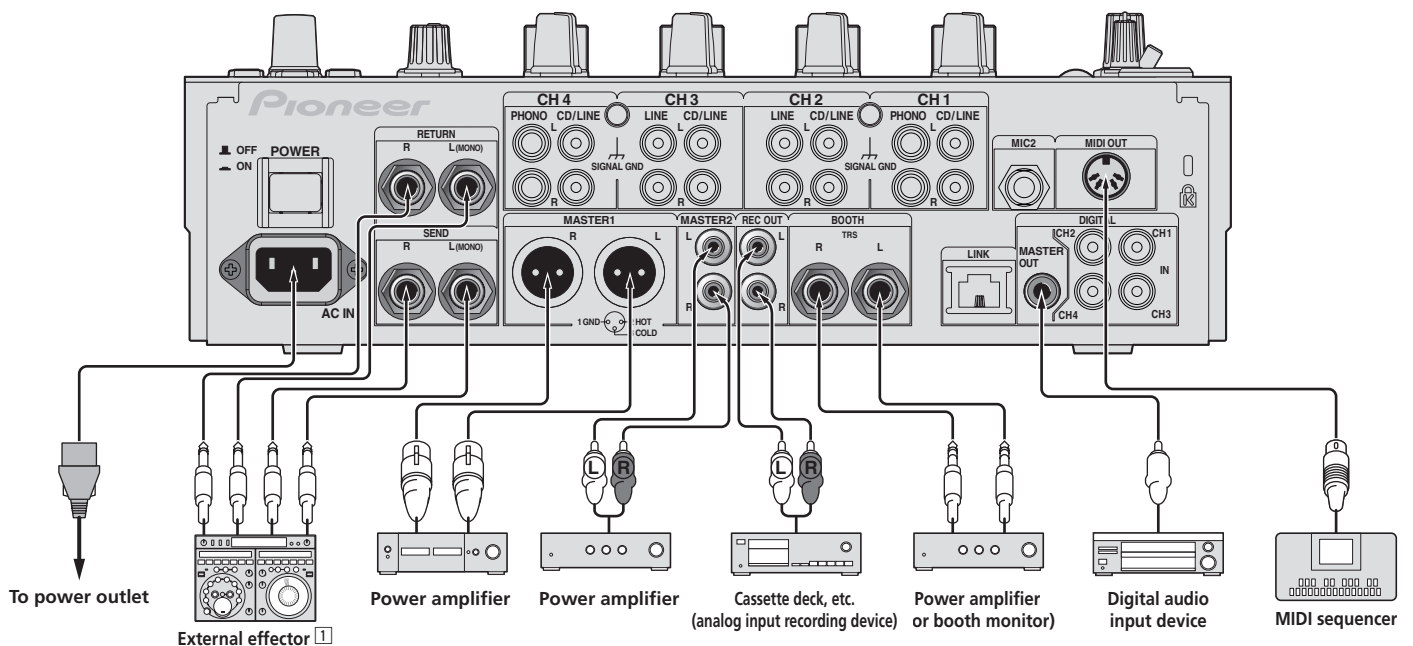

To power outlet

External effector <sup>1</sup>

Power amplifier

Power amplifier

Cassette deck, etc.  
(analog input recording device)

Power amplifier  
or booth monitor

Digital audio  
input device

MIDI sequencer

<sup>1</sup> Also connect the external effector to the [RETURN] terminal (input terminal).



## Connecting to the control panel

Be sure to connect using the included USB cable.

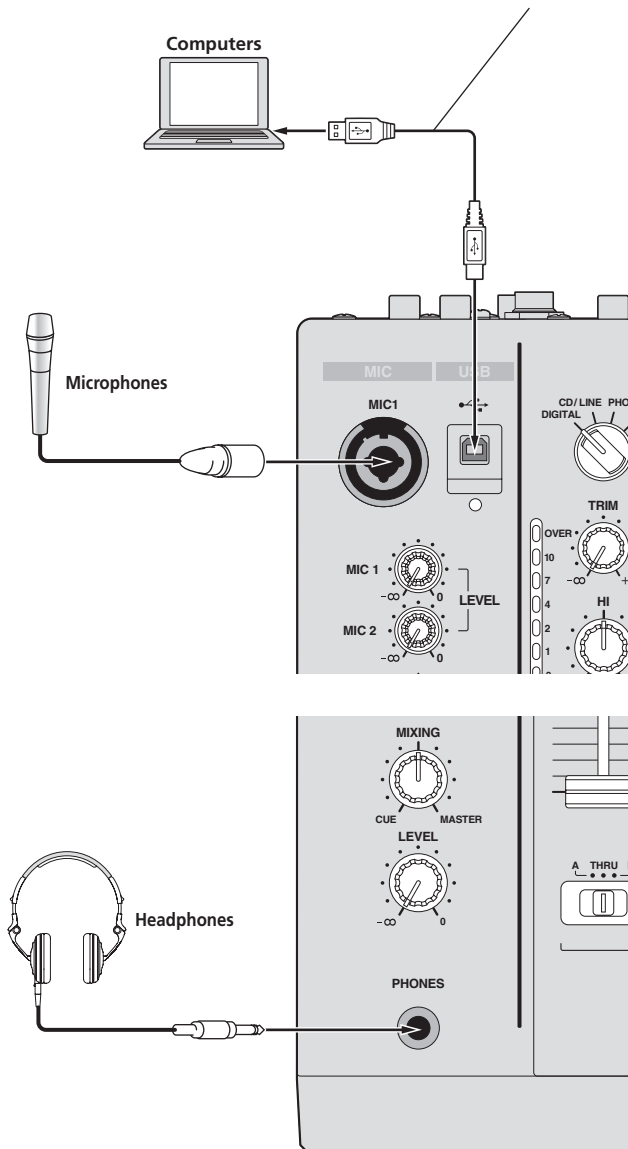

## About the driver software and setting utility software

This driver software is a proprietary program for inputting and outputting audio signals from the computer. To use this unit connected to a computer on which a Windows or Mac OS is installed, install the driver software on the computer beforehand.

## Software end user license agreement

This Software End User License Agreement ("Agreement") is between you (both the individual installing the Program and any single legal entity for which the individual is acting) ("You" or "Your") and PIONEER CORPORATION ("Pioneer"). TAKING ANY STEP TO SET UP OR INSTALL THE PROGRAM MEANS THAT YOU ACCEPT ALL OF THE TERMS OF THIS LICENSE AGREEMENT. PERMISSION TO DOWNLOAD AND/OR USE THE PROGRAM IS EXPRESSLY CONDITIONED ON YOUR FOLLOWING THESE TERMS. WRITTEN OR ELECTRONIC APPROVAL IS NOT REQUIRED TO MAKE THIS AGREEMENT VALID AND ENFORCEABLE. IF YOU DO NOT AGREE TO ALL OF THE TERMS OF THIS AGREEMENT, YOU ARE NOT AUTHORIZED TO USE THE PROGRAM AND MUST STOP INSTALLING IT OR UNINSTALL IT, AS APPLICABLE.

### 1 Definitions

- 1 "Documentation" means written documentation, specifications and help content made generally available by Pioneer to aid in installing and using the Program.
- 2 "Program" means all or any part of Pioneer's software licensed to You by Pioneer under this Agreement.

### 2 Program license

- 1 Limited License. Subject to this Agreement's restrictions, Pioneer grants to You a limited, non-exclusive, nontransferable, license (without the right to sublicense):
  - a To install a single copy of the Program on the hard disk drive of Your computer, to use the Program only for Your personal purpose complying with this Agreement and the Documentation ("Authorized Use");
  - b To use the Documentation in support of Your Authorized Use; and
  - c To make one copy of the Program solely for backup purposes, provided that all titles and trademark, copyright and restricted rights notices are reproduced on the copy.
- 2 Restrictions. You will not copy or use the Program or Documentation except as expressly permitted by this Agreement. You will not transfer, sublicense, rent, lease or lend the Program, or use it for third-party training, commercial time-sharing or service bureau use. You will not Yourself or through any third party modify, reverse engineer, disassemble or decompile the Program, except to the extent expressly permitted by applicable law, and then only after You have notified Pioneer in writing of Your intended activities. You will not use the Program on multiple processors without Pioneer's prior written consent.
- 3 Ownership. Pioneer or its licensor retains all right, title and interest in and to all patent, copyright, trademark, trade secret and other intellectual property rights in the Program and Documentation, and any derivative works thereof. You do not acquire any other rights, express or implied, beyond the limited license set forth in this Agreement.
- 4 No Support. Pioneer has no obligation to provide support, maintenance, upgrades, modifications or new releases for the Program or Documentation under this Agreement.

### 3 Warranty disclaimer

THE PROGRAM AND DOCUMENTATION ARE PROVIDED "AS IS" WITHOUT ANY REPRESENTATIONS OR WARRANTIES, AND YOU AGREE TO USE THEM AT YOUR SOLE RISK. TO THE FULLEST EXTENT PERMISSIBLE BY LAW, PIONEER EXPRESSLY DISCLAIMS ALL WARRANTIES OF ANY KIND WITH RESPECT TO THE PROGRAM AND DOCUMENTATION, WHETHER EXPRESS, IMPLIED, STATUTORY, OR ARISING OUT OF COURSE OF PERFORMANCE, COURSE OF DEALING OR USAGE OF TRADE, INCLUDING ANY WARRANTIES OF MERCHANTABILITY, FITNESS FOR A PARTICULAR PURPOSE, SATISFACTORY QUALITY, ACCURACY, TITLE OR NON-INFRINGEMENT.

### 4 Damages and remedies for breach

You agree that any breach of this Agreement's restrictions would cause Pioneer irreparable harm for which money damages alone would be inadequate. In addition to damages and any other remedies to which Pioneer may be entitled, You agree that Pioneer may seek injunctive relief to prevent the actual, threatened or continued breach of this Agreement.

### 5 Termination

Pioneer may terminate this Agreement at any time upon Your breach of any provision. If this Agreement is terminated, You will stop using the Program, permanently delete it from the computer where it resides, and destroy all copies of the Program and Documentation in Your possession, confirming to Pioneer in writing that You have done so. Sections 2.2, 2.3, 2.4, 3, 4, 5 and 6 will continue in effect after this Agreement's termination.

## 6 General terms

- 1** Limitation of Liability. In no event will Pioneer or its subsidiaries be liable in connection with this Agreement or its subject matter, under any theory of liability, for any indirect, incidental, special, consequential or punitive damages, or damages for lost profits, revenue, business, savings, data, use, or cost of substitute procurement, even if advised of the possibility of such damages or if such damages are foreseeable. In no event will Pioneer's liability for all damages exceed the amounts actually paid by You to Pioneer or its subsidiaries for the Program. The parties acknowledge that the liability limits and risk allocation in this Agreement are reflected in the Program price and are essential elements of the bargain between the parties, without which Pioneer would not have provided the Program or entered into this Agreement.
- 2** The limitations or exclusions of warranties and liability contained in this Agreement do not affect or prejudice Your statutory rights as consumer and shall apply to You only to the extent such limitations or exclusions are permitted under the laws of the jurisdiction where You are located.
- 3** Severability and Waiver. If any provision of this Agreement is held to be illegal, invalid or otherwise unenforceable, that provision will be enforced to the extent possible or, if incapable of enforcement, deemed to be severed and deleted from this Agreement, and the remainder will continue in full force and effect. The waiver by either party of any default or breach of this Agreement will not waive any other or subsequent default or breach.
- 4** No Assignment. You may not assign, sell, transfer, delegate or otherwise dispose of this Agreement or any rights or obligations under it, whether voluntarily or involuntarily, by operation of law or otherwise, without Pioneer's prior written consent. Any purported assignment, transfer or delegation by You will be null and void. Subject to the foregoing, this Agreement will be binding upon and will inure to the benefit of the parties and their respective successors and assigns.
- 5** Entire Agreement. This Agreement constitutes the entire agreement between the parties and supersedes all prior or contemporaneous agreements or representations, whether written or oral, concerning its subject matter. This Agreement may not be modified or amended without Pioneer's prior and express written consent, and no other act, document, usage or custom will be deemed to amend or modify this Agreement.
- 6** You agree that this Agreement shall be governed and construed by and under the laws of Japan.

## Cautions on Installation

- Before installing the driver software, be sure to turn off the power of this unit and disconnect the USB cable from both this unit and your computer.
- If you connect this unit to your computer without installing the driver software first, an error may occur on your computer depending on the system environment.
- If you have discontinued the installation process in progress, step through the installation process again from the beginning according to the following procedure.
- Read *Software end user license agreement* carefully before installing this unit's proprietary driver software.
- Before installing the driver software, terminate all other programs running on your computer.
- The driver software is compatible with the following OSs.

### Supported operating systems

Mac OS X (10.3.9 and later)		✓
Windows® 7 Home Premium/Professional/Ultimate	32-bit version	✓
	64-bit version	✓
Windows Vista® Home Basic/Home Premium/Business/Ultimate	32-bit version	✓
	64-bit version	✓
Windows® XP Home Edition/Professional (SP2 or later)	32-bit version	✓
Windows® XP Professional x64 Edition is not supported.		

- The included CD-ROM includes installation programs in the following 12 languages.  
English, French, German, Italian, Dutch, Spanish, Portuguese, Russian, Simplified Chinese, Traditional Chinese, Korean, and Japanese  
When using operating systems in other languages, follow the instructions on the screen to select **[English (English)]**.

## Installing the driver software

### ❖ Installation Procedure (Windows)

Read *Cautions on Installation* carefully before installing the driver software.

- To install or uninstall the driver software, you need to be authorized by the administrator of your computer. Log on as the administrator of your computer before proceeding with the installation.

#### 1 Insert the included CD-ROM into the computer's CD drive.

The CD-ROM folder appears.

- If the CD-ROM folder is not displayed after a CD-ROM is loaded, open the CD drive from **[Computer (or My Computer)]** in the **[Start]** menu.

#### 2 Double-click **[DJM-900nexus\_X.XXX.exe]**.

The driver installation screen appears.

#### 3 When the language selection screen appears, select **[English]** and click **[OK]**.

You can select one from multiple languages depending on the system environment of your computer.

#### 4 Carefully read the *Software end user license agreement* and if you consent to the provisions, put a check mark in **[I agree.]** and click **[OK]**.

If you do not consent to the provisions of the *Software end user license agreement*, click **[Cancel]** and stop installation.

#### 5 Proceed with installation according to the instructions on the screen.

If **[Windows Security]** appears on the screen while the installation is in progress, click **[Install this driver software anyway]** and continue with the installation.

- When installing on Windows XP  
If **[Hardware Installation]** appears on the screen while the installation is in progress, click **[Continue Anyway]** and continue with the installation.
- When the installation program is completed, a completion message appears.
- When the installation of the driver software is completed, you need to reboot your computer.

### ❖ Installation Procedure (Macintosh)

Read *Cautions on Installation* carefully before installing the driver software.

- To install or uninstall the driver software, you need to be authorized by the administrator of your computer. Have the name and password of the administrator of your computer ready in advance.

#### 1 Insert the included CD-ROM into the computer's CD drive.

The CD-ROM folder appears.

- Double-click the CD icon on the desktop when folders are not displayed after a CD-ROM has been loaded.

#### 2 Double-click **[DJM-900nexus\_M\_X.X.X.dmg]**.

The **[DJM-900nexusAudioDriver]** menu screen appears.

#### 3 Double-click **[DJM-900nexusAudioDriver.pkg]**.

The driver installation screen appears.

#### 4 Check the details on the screen and click **[Continue Anyway]**.

#### 5 When the Software Use Agreement screen appears, select **[English]**, carefully read the *Software end user license agreement* and click **[Continue Anyway]**.

You can select one from multiple languages depending on the system environment of your computer.

#### 6 If you consent to the provisions of the *Software end user license agreement*, click **[Agree]**.

If you do not consent to the provisions of the *Software end user license agreement*, click **[I disagree]** and stop installation.

#### 7 Proceed with installation according to the instructions on the screen.

- Click **[Cancel]** to cancel installation after it has started.
- When the installation of the driver software is completed, you need to reboot your computer.

## Connecting this unit and computer

### 1 Connect this unit to your computer via a USB cable.

This unit functions as an audio device conforming to the ASIO standards.

- This operation does not work with computers that do not support USB 2.0.
- When using ASIO-compatible applications, **[USB 1/2]**, **[USB 3/4]**, **[USB 5/6]** and **[USB 7/8]** can be used as inputs.
- When using DirectX-compatible applications, only **[USB 1/2]** can be used as the input.
- The computer's recommended operating environment depends on the DJ application. Be sure to check the recommended operating environment for the DJ application you are using.
- When another USB audio device is connected to the computer at the same time, it may not operate or be recognized normally.  
We recommend only connecting the computer and this unit.
- When connecting the computer and this unit, we recommend connecting directly to this unit's USB port.

### 2 Press **[POWER]** button.

Turn on the power of this unit.

- The message [Installing device driver software] may appear when this unit is first connected to the computer or when it is connected to a different USB port on the computer. Wait awhile until the message [Your devices are ready for use] appears.
- When installing on Windows XP
  - [Can Windows connect to Windows Update to search for software?] may appear while the installation is in progress. Select [No, not this time], then click [Next] to continue installation.
  - [What do you want the wizard to do?] may appear while the installation is in progress. Select [Install the software automatically (Recommended)], then click [Next] to continue installation.
  - If [Windows Security] appears on the screen while the installation is in progress, click [Install this driver software anyway] and continue with the installation.

## About the setting utility software

The setting utility can be used to make the checks and settings described below.

- Checking the status of this unit's [DIGITAL, CD/LINE, PHONO, LINE, USB \*/\*] selector switch
- Setting the audio data output from this unit to the computer
- Adjusting the buffer size (when using Windows ASIO)
- Checking the version of the driver software

### ❖ Displaying the setting utility

#### For Windows

Click [Start] menu > [All Programs] > [Pioneer] > [DJM-900nexus] > [DJM-900nexus Settings Utility].

#### For Mac OS X

Click [Macintosh HD] icon > [Application] > [Pioneer] > [DJM-900nexus] > [DJM-900nexus Settings Utility].

### ❖ Checking the status of this unit's [DIGITAL, CD/LINE, PHONO, LINE, USB \*/\*] selector switch

Display the setting utility before starting.

#### Click the [MIXER INPUT] tab.

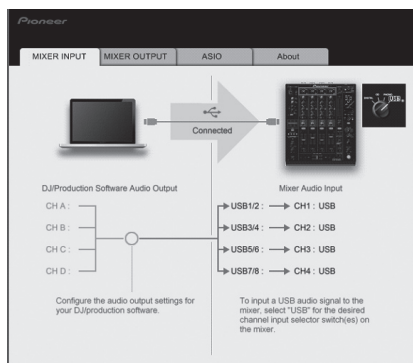

### ❖ Setting the audio data output from this unit to the computer

Display the setting utility before starting.

#### 1 Click the [MIXER OUTPUT] tab.

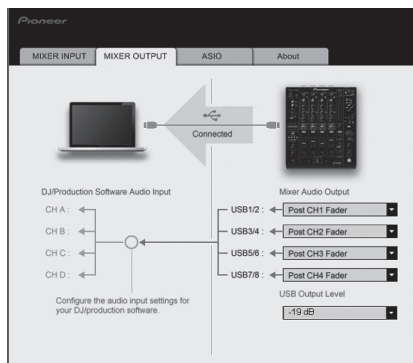

#### 2 Click the [Mixer Audio Output] pull-down menu.

Select and set the audio data to be output to the computer from the flow of audio signals inside this unit.

CH1	CH2	CH3	CH4
CH1 Timecode PHONO <sup>[1]</sup>	CH2 Timecode CD/LINE <sup>[1]</sup>	CH3 Timecode CD/LINE <sup>[1]</sup>	CH4 Timecode PHONO <sup>[1]</sup>
CH1 Timecode CD/LINE <sup>[1]</sup>	CH2 Timecode LINE <sup>[1]</sup>	CH3 Timecode LINE <sup>[1]</sup>	CH4 Timecode CD/LINE <sup>[1]</sup>
CH1 Timecode DIGITAL <sup>[1]</sup>	CH2 Timecode DIGITAL <sup>[1]</sup>	CH3 Timecode DIGITAL <sup>[1]</sup>	CH4 Timecode DIGITAL <sup>[1]</sup>
POST CH1 Fader <sup>[2]</sup>	POST CH2 Fader <sup>[2]</sup>	POST CH3 Fader <sup>[2]</sup>	POST CH4 Fader <sup>[2]</sup>
Cross Fader A <sup>[2]</sup>	Cross Fader A <sup>[2]</sup>	Cross Fader A <sup>[2]</sup>	Cross Fader A <sup>[2]</sup>
Cross Fader B <sup>[2]</sup>	Cross Fader B <sup>[2]</sup>	Cross Fader B <sup>[2]</sup>	Cross Fader B <sup>[2]</sup>
MIC	MIC	MIC	MIC
REC OUT <sup>[2]</sup>	REC OUT <sup>[2]</sup>	REC OUT <sup>[2]</sup>	REC OUT <sup>[2]</sup>

[1]: The audio data is output with the same volume at which it is input to this unit, regardless of the [USB Output Level] setting.

[2]: When using for applications other than recording, pay attention to the DJ application's settings so that no audio loops are generated. If audio loops are generated, sound may be input or output at unintended volumes.

### 3 Click the [USB Output Level] pull-down menu.

Adjust the volume of the audio data output from this unit.

- The [USB Output Level] setting is applied equally to all audio data. However, when [1] on the table at step 2 is selected, the audio data is output with the same volume at which it is input to this unit.
- If not enough volume can be achieved with the DJ software's volume adjustment alone, change the [USB Output Level] setting to adjust the volume of the audio data output from this unit. Note that the sound will be distorted if the volume is raised too high.

### ❖ Adjusting the buffer size (when using Windows ASIO)

If an application using this unit as the default audio device (DJ software, etc.) is running, quit that application before adjusting the buffer size. Display the setting utility before starting.

#### Click the [ASIO] tab.

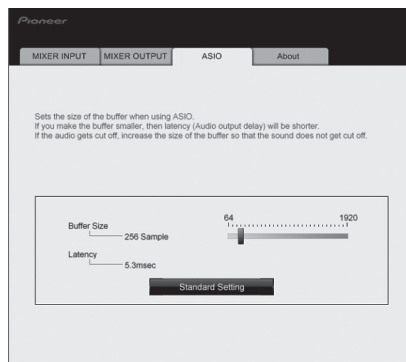

- If the buffer size is made large, drops in audio data (breaks in the sound) occur less easily, but the time lag due to the delay in the transfer of the audio data (latency) increases.

### ❖ Checking the version of the driver software

Display the setting utility before starting.

#### Click the [About] tab.

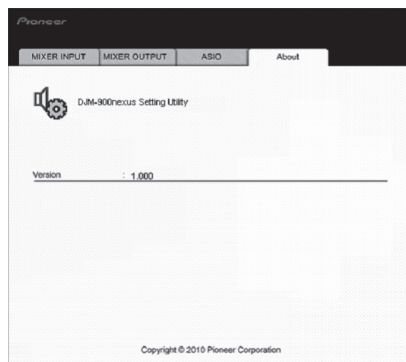

## Checking the latest information on the driver software

For the latest information on the driver software for exclusive use with this unit, visit our website shown below.

<http://www.prodjnet.com/support/>

- Operation cannot be guaranteed when multiple units of this mixer are connected to a single computer.

# Operations

## Control Panel

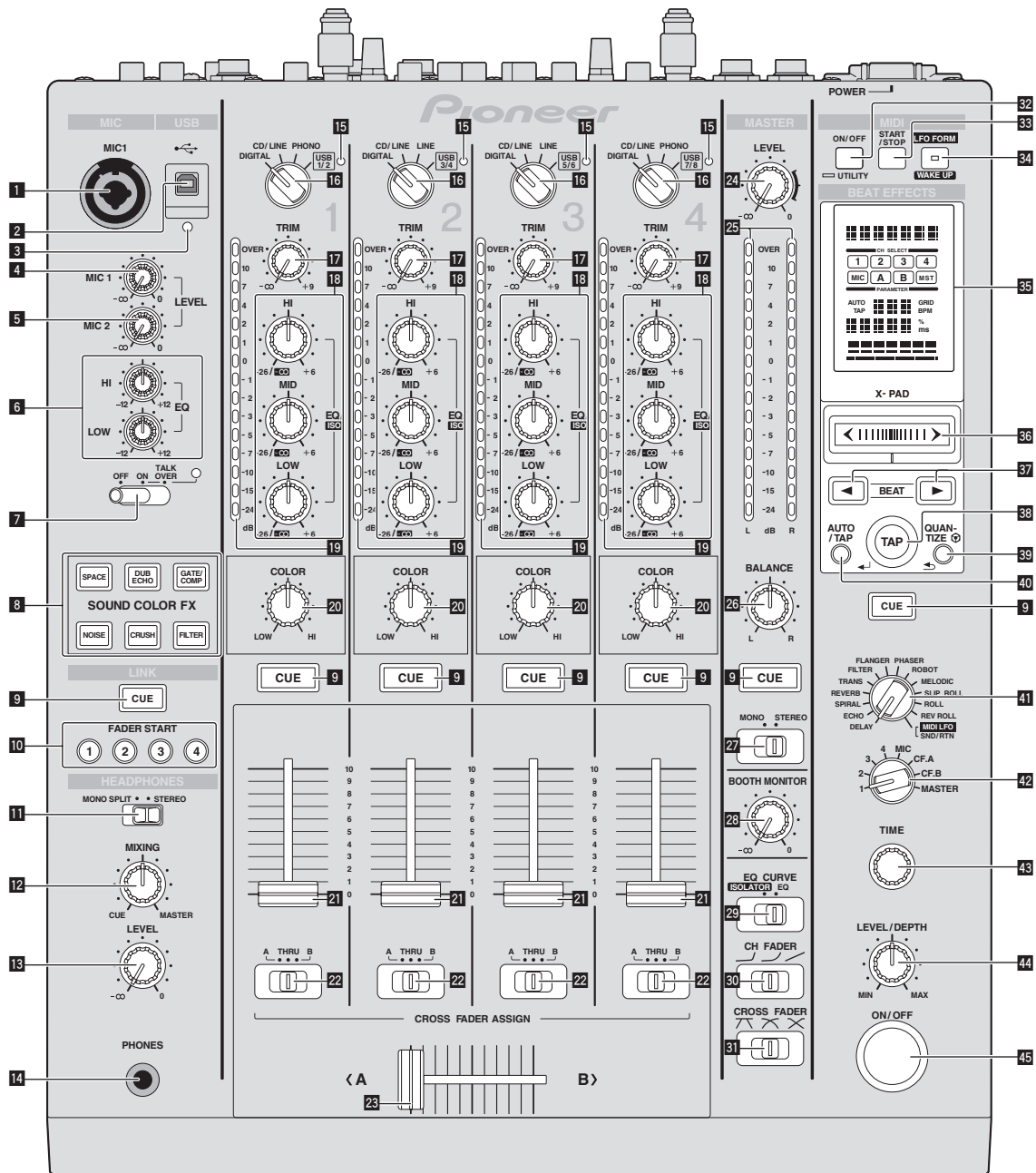

**1 MIC1 terminal (page 15)**

Connect a microphone here.

**2 USB terminal (page 9)**

Connect the computer.

**3 USB connection indicator**

Lights when signals are being exchanged with the computer.

**4 MIC1 LEVEL control (page 15)**

Adjusts the sound level output from the [MIC1] channel.

**5 MIC2 LEVEL control (page 15)**

Adjusts the sound level output from the [MIC2] channel.

**6 EQ (HI, LOW) controls (page 15)**

These adjust the tone quality of the [MIC1] and [MIC2] channels.

**7 OFF, ON, TALK OVER selector switch (page 15)**

Turns the microphone on/off.

**8 SOUND COLOR FX buttons (page 15)**

These turn the SOUND COLOR FX effects on/off.

**9 CUE buttons (page 14)**

Press the [CUE] button(s) for the channel(s) you want to monitor.

**10 FADER START (1, 2, 3, 4) buttons (page 14)**

These turn the fader start function on/off.

**11 MONO SPLIT, STEREO selector switch (page 14)**

Switches how the monitor sound output from the headphones is distributed.

**12 MIXING controls (page 14)**

These adjust the monitor volume balance of the sound of channels for which the [CUE] button is pressed and the sound of the [MASTER] channel.

**13 LEVEL control (page 14)**

Adjusts the sound level output from the headphones.

**14 PHONES terminal (page 14)**

Connect headphones here.

**15 USB audio input indicator**

Lights when sound is being input from the computer to the various channels.

- 16 DIGITAL, CD/LINE, PHONO, LINE, USB \*/\* selector switch (page 14)**  
Select the input source of each channel from the components connected to this unit.
- 17 TRIM control (page 14)**  
Adjusts the level of audio signals input in each channel.
- 18 EQ/ISO (HI, MID, LOW) controls (page 14)**  
These adjust the sound quality of the different channels.
- 19 Channel Level Indicator (page 14)**  
Displays the sound level of the different channels before passing through the channel faders.
- 20 COLOR controls (page 15)**  
These change the parameters of the SOUND COLOR FX of the different channels.
- 21 Channel Fader (page 14)**  
Adjusts the level of audio signals output in each channel.
- 22 CROSS FADER ASSIGN (A, THRU, B) selector switch (page 14)**  
Set the output destination of each channel to [A] or [B].
- 23 Crossfader (page 14)**  
Outputs audio signals assigned by the crossfader assign switch corresponding to the curve characteristics selected by [CROSS FADER] (Crossfader Curve Selector Switch).
- 24 MASTER LEVEL controls (page 14)**  
Adjusts the sound level output from the [MASTER] channel.
- 25 Master Level Indicator (page 14)**  
Displays the sound level output from the [MASTER] channel.
- 26 BALANCE controls (page 15)**  
Adjusts the left/right balance of the sound output from the [MASTER1] terminals, etc.
- 27 MONO, STEREO selector switch (page 15)**  
Switches the sound output from the [MASTER1] terminals, etc., between mono-aural and stereo.
- 28 BOOTH MONITOR controls (page 15)**  
Adjusts the level of audio signals output at the [BOOTH] terminal.
- 29 EQ CURVE (ISOLATOR, EQ) selector switch (page 14)**  
Switches the function of the [EQ/ISO (HI, MID, LOW)] controls.
- 30 CH FADER (↵, ↘, ↗) selector switch (page 14)**  
Switches the channel fader's curve characteristics.
- 31 CROSS FADER (↖, ↗, ✕) selector switch (page 14)**  
This switches the crossfader curve characteristics.
- 32 ON/OFF (UTILITY) button**  
— **ON/OFF**: Turns the MIDI function on/off (page 17).  
— **UTILITY**: Displays the [USER SETUP] or [CLUB SETUP] screen (page 23).
- 33 START/STOP button (page 17)**  
Sends the MIDI start/MIDI stop signals.
- 34 LFO FORM (WAKE UP) button**  
— **LFO FORM**: When [MIDI LFO] is selected at BEAT EFFECT, the MIDI signal's waveform switches each time the button is pressed (page 20).  
— **WAKE UP**: Cancels the auto standby mode (page 23).
- 35 Main unit display**
- 36 X-PAD (page 16)**  
Adjusts the quantitative parameter of the BEAT EFFECT function.
- 37 BEAT ◀, ▶ buttons (page 16)**  
Sets the beat fraction for synchronizing the effect sound.
- 38 TAP (ENTER) button**  
— **TAP**: When the BPM measurement mode is set to [TAP], the BPM is input manually by tapping the button with a finger (page 16).  
— **ENTER**: Used to change this unit's settings (page 23).
- 39 QUANTIZE button**  
• Used to change this unit's settings (page 23).  
• When the QUANTIZE function is turned on for BEAT EFFECT, the effect is applied to the sound without going off tempo when the currently playing track. (page 16).
- 40 AUTO/TAP button (page 16)**  
Switches the BPM measurement mode.

**41 DELAY, ECHO, SPIRAL, REVERB, TRANS, FILTER, FLANGER, PHASER, ROBOT, MELODIC, SLIP ROLL, ROLL, REV ROLL, SND/RTN (MIDI LFO) selector switch (page 16)**

Switches the BEAT EFFECT effect type.

**42 1, 2, 3, 4, MIC, CF.A, CF.B, MASTER selector switch (page 16)**

Switches the channel to which the BEAT EFFECT is to be applied.

**43 TIME control (page 16)**

Adjust the BEAT EFFECT's time parameter.

**44 LEVEL/DEPTH control (page 16)**

Adjusts the BEAT EFFECT's quantitative parameter.

**45 ON/OFF button (page 16)**

Turns the BEAT EFFECT function on/off.

Do not pull on the channel fader and crossfader knobs with excessive force. The knobs are not designed to be removed. Pulling the knobs strongly may result in damaging the unit.

---

---

## Basic Operation

---

### Outputting sound

#### 1 Press [POWER] button.

Turn on the power of this unit.

#### 2 Turn the [DIGITAL, CD/LINE, PHONO, LINE, USB \*/\*] selector switch.

Select the input sources for the different channels from among the devices connected to this unit.

- [DIGITAL]: Selects the DJ player connected to the [DIGITAL] terminals.
- [PHONO]: Selects the analog player connected to the [PHONO] terminals.
- [CD/LINE], [LINE]: Selects the cassette deck or CD player connected to the [LINE] terminals.
- [USB \*/\*]: Selects the sound of the computer connected to the [USB] port.

#### 3 Turn the [TRIM] control.

Adjusts the level of audio signals input in each channel.

The corresponding channel level indicator lights when audio signals are being properly input to that channel.

#### 4 Set the channel fader to the inner position.

Adjusts the level of audio signals output in each channel.

#### 5 Switch the [CROSS FADER ASSIGN (A, THRU, B)] selector switch.

Switches the output destination of each channel.

- [A]: Assigns to [A] (left) of the crossfader.
- [B]: Assigns to [B] (right) of the crossfader.
- [THRU]: Select this when you do not want to use the crossfader. (The signals do not pass through the crossfader.)

#### 6 Set the crossfader.

This operation is not necessary when the [CROSS FADER ASSIGN (A, THRU, B)] selector switch is set to [THRU].

#### 7 Turn the [MASTER LEVEL] control.

Audio signals are output from the [MASTER1] and [MASTER2] terminals. The master level indicator lights.

---

### Adjusting the sound quality

#### Turn the [EQ/ISO (HI, MID, LOW)] controls for the different channels.

Refer to *Specifications* on page 26 for the range of sound that can be adjusted by each control.

#### ❖ Switching the function of the [EQ/ISO (HI, MID, LOW)] controls

##### Switch the [EQ CURVE (ISOLATOR, EQ)] selector switch.

- [ISOLATOR]: Functions as an isolator.
  - [EQ]: The equalizer function is set.
- 

### Monitoring sound with headphones

#### 1 Connect headphones to the [PHONES] jack.

#### 2 Press the [CUE] button(s) for the channel(s) you want to monitor.

#### 3 Switch the [MONO SPLIT, STEREO] selector switch.

- [MONO SPLIT]: The sound of the channels for which the [CUE] button is pressed is output from the headphones output's left channel, the [MASTER] channel sound is output from the right channel.
- [STEREO]: The sound of the channels for which the [CUE] button is pressed is output from the headphones in stereo.

#### 4 Turn the [MIXING] control.

These adjust the monitor volume balance of the sound of channels for which the [CUE] button is pressed and the sound of the [MASTER] channel.

#### 5 Turn the [LEVEL] control for [HEADPHONES].

The sound of the channels for which the [CUE] button is pressed is output from the headphones.

- When the [CUE] button is pressed again, monitoring is canceled.
- 

---

---

### Monitoring the sound of the computer

- Check [Use "LINK MONITOR" of Pioneer DJ Mixers.] at [File] > [Preferences] > [Audio] in rekordbox beforehand. Also refer to the rekordbox operating instructions.

#### 1 Connect headphones to the [PHONES] jack.

#### 2 Connect a computer on which rekordbox is installed.

For instructions on connections, see *Connecting input terminals* on page 8.

#### 3 Selecting the track to be monitored with rekordbox

#### 4 Press the [CUE] button for [LINK].

The track selected with rekordbox is output from the headphones.

- When the [CUE] button is pressed again, monitoring is canceled.
  - The same operation as at *Monitoring sound with headphones* (steps 3 to 5) can be performed.
- 

### Switching the fader curve

#### ❖ Select the channel fader curve characteristics.

##### Switch the [CH FADER (↵, ↶, ↷)] selector switch.

- [↵]: The curve rises suddenly at the back side.
- [↶]: A curve between the ones above and below is set.
- [↷]: The curve rises gradually (the sound gradually increases as the channel fader is moved away from the front side).

#### ❖ Select the crossfader curve characteristics.

##### Switch the [CROSS FADER (↖, ↗, ✕)] selector switch.

- [↖]: Makes a sharply increasing curve (if the crossfader is moved away from the [A] side, audio signals are immediately output from the [B] side).
  - [↗]: Makes a curve shaped between the two curves above and below.
  - [✕]: Makes a gradually increasing curve (if the crossfader is moved away from the [A] side, the sound on the [B] side gradually increases, while the sound on the [A] side gradually decreases).
- 

### Starting playback on a DJ player using the fader (fader start)

When connected to a Pioneer DJ player by LAN cable, such operations as starting playback on the DJ player can be controlled using this unit's fader.

Connect this unit and Pioneer DJ player beforehand. For instructions on connections, see *Connecting input terminals* on page 8.

For instructions on setting the player numbers of Pioneer DJ players, see *About PRO DJ LINK* on page 15.

The fader start function can be switched on and off for all DJ players all at once. For the switching procedure, see *Changing the settings* on page 23.

#### ❖ Start playback using the channel fader

##### 1 Set the [CROSS FADER ASSIGN (A, THRU, B)] selector switch to [THRU].

##### 2 Press one of the [FADER START (1, 2, 3, 4)] buttons.

Select the channel to be started with the fader start function.

##### 3 Set the channel fader to the outermost position.

##### 4 Set the cue on the DJ player.

The DJ player pauses playback at the cue point.

##### 5 Set the channel fader to the inner position.

Playback starts on the DJ player.

- If you set the channel fader back to the original position, the player instantaneously returns to the cue point already set and pauses playback (back cue).

#### ❖ Start playback using the crossfader

##### 1 Set the [CROSS FADER ASSIGN (A, THRU, B)] selector switch to [A] or [B].

##### 2 Press one of the [FADER START (1, 2, 3, 4)] buttons.

Select the channel to be started with the fader start function.

##### 3 Set the crossfader.

Set to the edge opposite the side on which the channel you want to use with the fader start function is set.

---

#### 4 Set the cue on the DJ player.

The DJ player pauses playback at the cue point.

#### 5 Set the crossfader.

Playback starts on the DJ player.

- If you set the crossfader back to the original position, the player instantaneously returns to the cue point already set and pauses playback (back cue).

## Using a microphone

### 1 Connect a microphone to the [MIC1] or [MIC2] terminal.

### 2 Set the [OFF, ON, TALK OVER] selector switch to [ON] or [TALK OVER].

- [ON]: The indicator lights.
- [TALK OVER]: The indicator flashes.
- When set to [TALK OVER], the sound of channels other than the [MIC] channel is attenuated by 18 dB (default) when a sound of -10 dB or greater is input to the microphone.
- The [TALK OVER] sound attenuation level can be changed at [USER SETUP]. For instructions on changing this, see *Changing the settings* on page 23.

### 3 Turn the [MIC1 LEVEL] or [MIC2 LEVEL] control.

Adjust the level of the sound output from the [MIC] channel.

- Pay attention that rotating to the extreme right position outputs a very loud sound.

### 4 Input audio signals to the microphone.

#### ❖ Adjusting the sound quality

#### Turn the [MIC] channels' [EQ (HI, LOW)] controls.

Refer to *Specifications* on page 26 for the range of sound that can be adjusted by each control.

## Switching between monaural and stereo audio

This switches the sound output from the [MASTER1], [MASTER2], [BOOTH], [REC OUT], [PHONES], [DIGITAL MASTER OUT] and [USB] terminals between monaural and stereo.

- To adjust the sound output from the [USB] terminals, select [REC OUT] at [Mixer Audio Output] in the setting utility.

### Switch the [MONO, STEREO] selector switch.

- [MONO]: Outputs monaural audio.
- [STEREO]: Outputs stereo audio.

#### ❖ Adjusting the L/R balance of audio

The left/right balance of the sound output from the [MASTER1], [MASTER2], [BOOTH], [REC OUT], [PHONES], [DIGITAL MASTER OUT] and [USB] terminals can be adjusted.

- To adjust the sound output from the [USB] terminals, select [REC OUT] at [Mixer Audio Output] in the setting utility.

### 1 Set the [MONO, STEREO] selector switch to [STEREO].

### 2 Turn the [BALANCE] control.

The sound's left/right balance changes according to the direction in which the [BALANCE] control is turned and its position.

- Rotating to the rightmost position outputs only the right sound of stereo audio. Rotating to the leftmost position outputs only the left sound of stereo audio.

## Audio is output from the [BOOTH] terminal

### Turn the [BOOTH MONITOR] control.

Adjusts the level of audio signals output at the [BOOTH] terminal.

## Advanced Operations

### About PRO DJ LINK

When a PRO DJ LINK-compatible Pioneer DJ player (CDJ-2000, CDJ-900 etc.), a computer on which rekordbox is installed and this unit are connected by LAN cable, the PRO DJ LINK functions below can be used.

For more details on the PRO DJ LINK function, also refer to the DJ player's handling instructions and rekordbox's operating instructions.

For instructions on connections, see *Connecting input terminals* on page 8.

- When connected using a switching hub, up to 4 DJ players and 2 computers can be connected.
- Use a 100Base-TX-compatible switching hub. Some switching hubs may not operate properly.
- Set the DJ player's player number to the same number as the channel to which the audio cable is connected.

#### ❖ LINK MONITOR

With this function, rekordbox music files stored on the computer can be quickly monitored over the headphones.

#### ❖ STATUS INFORMATION

This function informs the DJ players of the connected channel status (on-air status, channel number, etc.).

#### ❖ QUANTIZE

When tracks analyzed with rekordbox are used, the track is put on beat even when the [ON/OFF] button of [BEAT EFFECTS] is pressed or the [X-PAD] is touched roughly.

#### ❖ FADER START

Playback on the DJ player can be started by operating this unit's fader (Fader Start Play).

## SOUND COLOR FX

These effects change in association with the [COLOR] controls for the different channels.

### 1 Press one of the [SOUND COLOR FX] buttons.

This selects the type of effect.

The button that was pressed flashes.

- For the types of effects, see *Types of SOUND COLOR FX effects* on page 18.
- The same effect is set for [CH1] to [CH4].

### 2 Turn the [COLOR] control.

The effect is applied to the channel(s) for which the control(s) was (were) pressed.

## BEAT EFFECT

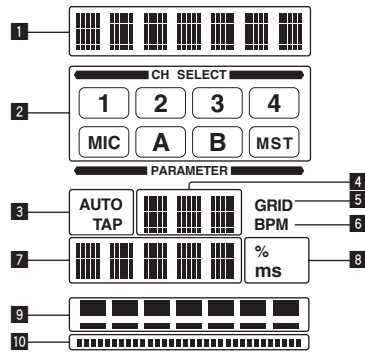

This function lets you instantaneously set various effects according to the tempo (BPM = Beats Per Minute) of the currently playing track.

1	Effect display section	The name of the selected effect is displayed.
2	Channel select display section	The name of the channel to which the effect is applied is displayed.
3	AUTO (TAP)	[AUTO] lights when the BPM measurement mode is set to the auto mode. [TAP] lights when in the manual input mode.
4	BPM value display (3 digits)	When in the auto mode, this displays the automatically detected BPM value. When the BPM cannot be detected, the previously detected BPM value is displayed and flashes. When in the manual input mode, this displays the BPM value that was input manually.
5	GRID	When playing tracks that have been analyzed with rekordbox, this lights when the QUANTIZE function can be used in combination with the DJ player. This flashes or remains off if the QUANTIZE function cannot be used.
6	BPM	This is always lit.
7	Parameter display section	This displays the parameters specified for the individual effects. When the [BEAT ◀, ▶] button is pressed, the corresponding beat fraction is displayed for 1 second. When a value outside the parameter range is specified with the [BEAT ◀, ▶] button, the value does not change and the display flashes.
8	% (ms)	These light according to the units for the different effects.
9	Beat display section	This lights according to the selected beat number position.
10	Touch display section	This lights when the [X-PAD] is touched.

### 1 Press [AUTO/TAP] button.

Select the BPM measurement mode.

- [AUTO]: The BPM is measured automatically from the audio signal that is being input. The [AUTO] mode is set when this unit's power is turned on.
- [TAP]: The BPM is input manually by tapping the [TAP] button with a finger.
- The [AUTO] BPM measurement range is BPM = 70 to 180. With some tracks it may not be possible to measure the BPM correctly. If the BPM cannot be measured, the BPM value on the display flashes. In such cases, use the [TAP] button to input the BPM manually.

### 2 Turn the [DELAY, ECHO, SPIRAL, REVERB, TRANS, FILTER, FLANGER, PHASER, ROBOT, MELODIC, SLIP ROLL, ROLL, REV ROLL, SND/RTN (MIDI LFO)] selector switch.

This selects the type of effect.

- For the types of effects, see *Types of BEAT EFFECT* on page 18.
- To use [SND/RTN], see *Using the external effector* below.
- To use [MIDI LFO], see *Using the MIDI LFO* on page 17.

### 3 Turn the [1, 2, 3, 4, MIC, CF.A, CF.B, MASTER] selector switch.

This selects the channel to which the effect is applied.

- [1] – [4]: The effect is applied to the sound of the respective channel.
- [MIC]: The effect is applied to the sound of [MIC] channel.
- [CF.A], [CF.B]: The effect is applied to the sound of the crossfader's [A] (left) or [B] (right) side.
- [MASTER]: The effect is applied to the sound of the [MASTER] channel.
- This operation is not necessary when [MIDI LFO] is selected.

### 4 Press the [BEAT ◀, ▶] button.

Sets the beat fraction for synchronizing the effect sound.

The effect time corresponding to the beat fraction is set automatically.

### 5 Press the [ON/OFF] button for [BEAT EFFECTS].

The effect is applied to the sound.

The effect's time parameter can be adjusted by turning the [TIME] control.

The effect's quantitative parameter can be adjusted by turning the [LEVEL/DEPTH] control.

The [ON/OFF] button flashes when the effect is on.

- When the [ON/OFF] button is pressed again, the effect turns off.

### ❖ Inputting the BPM manually

Tap the [TAP] button at least 2 times in rhythm with the beat (in quarter notes) of the sound being played.

The average value of the interval at which the [TAP] button was tapped by finger is set as the BPM.

- When the BPM is set using the [TAP] button, the beat fraction is set to [1/1] and the time of one beat (quarter note) is set as the effect time.
- The BPM can be set manually by turning the [TIME] control while pressing the [TAP] button.
- The BPM can be set in units of 0.1 by pressing the [AUTO/TAP] button while pressing the [TAP] button and turning the [TIME] control while pressing the two buttons.

### ❖ Using the external effector

#### 1 Connect this unit and external effector.

For instructions on connections, see *Connecting output terminals* on page 8.

#### 2 Turn the [DELAY, ECHO, SPIRAL, REVERB, TRANS, FILTER, FLANGER, PHASER, ROBOT, MELODIC, SLIP ROLL, ROLL, REV ROLL, SND/RTN (MIDI LFO)] selector switch.

Select [SND/RTN (MIDI LFO)].

#### 3 Turn the [1, 2, 3, 4, MIC, CF.A, CF.B, MASTER] selector switch.

This selects the channel to which the effect is applied.

#### 4 Press the [ON/OFF] button for [BEAT EFFECTS].

The sound that has passed through the external effector is output from the [MASTER] channel.

- When the [ON/OFF] button is pressed again, the effect turns off.

### ❖ Using the QUANTIZE function

Based on the GRID information of tracks that have been analyzed with rekordbox, effects can be added to the sound without getting out of tempo with the currently playing track.

Connect this unit and PRO DJ LINK-compatible Pioneer DJ player in advance. For instructions on connections, see *Connecting input terminals* on page 8.

Music files must be analyzed with rekordbox in advance in order to use the QUANTIZE function. For instructions on analyzing music files with rekordbox, also refer to the rekordbox operating instructions.

- The QUANTIZE function cannot be used when [REVERB], [ROBOT], [MELODIC] or [SND/RTN (MIDI LFO)] is selected.
- To use in combination with the CDJ-2000 or CDJ-900, first update the firmware to version 4.0 or later. (As of February 2011)

#### 1 Press the [QUANTIZE] button.

The QUANTIZE function turns on.

[GRID] lights on this unit's main unit display when the GRID information has been properly received from the DJ player and the QUANTIZE function can be used.

[GRID] flashes if the GRID information could not be properly received.

- Depending on the status of the DJ player (off air, scratching, reverse playing, etc.), it may not be possible to receive the GRID information.

#### 2 Press the [ON/OFF] button of [BEAT EFFECTS] or touch the [X-PAD].

The effect is added to the sound in tempo with the track being played.

- When the [QUANTIZE] button is pressed again, the QUANTIZE function turns off.

## Operating the [X-PAD]

Operating procedure	[ON/OFF] button status of [BEAT EFFECTS]	X-PAD	Effect
①	Off (lit)	Release ↔ Touch	On ↔ Off
②	On (flashing)	Release ↔ Touch	On ↔ On

### ❖ Operating procedure ①

#### 1 Perform steps 1 to 4 of the BEAT EFFECT procedure.

#### 2 Touch the [X-PAD].

The [X-PAD] turns the effect on and off and changes the quantitative parameter.

- When you release your finger from the [X-PAD], the effect turns off.
- To keep the effect on when you release your finger from the [X-PAD], while touching the [X-PAD] press the [ON/OFF] button of [BEAT EFFECTS], then release your finger from the [X-PAD].



## ❖ Operating procedure ②

### 1 Perform steps 1 to 5 of the BEAT EFFECT procedure.

### 2 Touch the [X-PAD].

The [X-PAD] changes the effect's quantitative parameter.

## Operating DJ software using the MIDI function

This unit outputs the operation information of buttons and controls in universal MIDI format.

When connected by USB cable to a computer on which a MIDI-compatible DJ software program is installed, the DJ software can be operated from this unit.

Install the DJ software on your computer in advance. Also, adjust audio and MIDI settings for the DJ software.

- For MIDI channel setting instructions, see *Changing the settings* on page 23.
- For the messages output by this unit, see *List of MIDI Messages* on page 21.

### 1 Connect this unit's [USB] terminal to the computer.

For details about connections, see *Connecting to the control panel* on page 9.

### 2 Start the DJ software.

### 3 Press the [ON/OFF (UTILITY)] button.

Turn the MIDI function on.

Transmission of the MIDI messages begin.

- When a fader or control is moved, a message corresponding to the position is sent.
- When the [START/STOP] button is pressed and held in for more than 2 seconds, a set of MIDI messages corresponding to the button, fader or control positions is sent (Snapshot).
- When the [ON/OFF (UTILITY)] button is pressed again, sending of the MIDI messages is stopped.
- The MIDI timing clock (BPM information) is sent regardless of the status of the [ON/OFF (UTILITY)] button.

## ❖ Making the preparations to use the MIDI LFO function

The MIDI-compatible software, devices, etc. (referred to as the "MIDI signal reception side" below) must be prepared ("learned") before using the MIDI LFO function.

Perform the learning operations on the MIDI signal reception side.

- For the messages output by this unit, see *List of MIDI Messages* on page 21.

### 1 Press the [ON/OFF (UTILITY)] button.

Turn the MIDI function on.

### 2 Turn the [DELAY, ECHO, SPIRAL, REVERB, TRANS, FILTER, FLANGER, PHASER, ROBOT, MELODIC, SLIP ROLL, ROLL, REV ROLL, SND/RTN (MIDI LFO)] selector switch.

Select [SND/RTN (MIDI LFO)].

[S/R ⇌ LFO] flashes on the effect display section, then [SND/RTN] is displayed.

### 3 Press the [ON/OFF] button for [BEAT EFFECTS].

Learn the [ON/OFF] button's MIDI message of the [BEAT EFFECTS] in the MIDI signal reception side.

- The MIDI message sent from the [ON/OFF] button of the [BEAT EFFECTS] differs when [SND/RTN (MIDI LFO)] is selected and when anything other than [SND/RTN (MIDI LFO)] is selected.

The [ON/OFF] button's MIDI message of [BEAT EFFECTS] when [SND/RTN (MIDI LFO)] is selected is only sent when the operation is performed following this procedure.

### 4 Press the [LFO FORM (WAKE UP)] button.

Learn the [LFO FORM (WAKE UP)] button's MIDI message in the MIDI signal reception side.

[1/7 ▲▲▲] and [1/7 LFO] are displayed alternately on the effect display section.

- If necessary, set the MIDI mapping for other buttons and controls. Because the [LFO FORM (WAKE UP)] button's MIDI message is sent sequentially, depending on the MIDI signal reception side's settings, it may not be possible to learn the MIDI message. To set the MIDI mapping for other buttons and controls, press the [LFO FORM (WAKE UP)] button to switch to [SND/RTN].

## ❖ Using the MIDI LFO

Make the preparations following the procedure at *Making the preparations to use the MIDI LFO function* beforehand.

### 1 Turn the [DELAY, ECHO, SPIRAL, REVERB, TRANS, FILTER, FLANGER, PHASER, ROBOT, MELODIC, SLIP ROLL, ROLL, REV ROLL, SND/RTN (MIDI LFO)] selector switch.

Select [SND/RTN (MIDI LFO)].

[S/R ⇌ LFO] flashes on the effect display section, then [SND/RTN] is displayed.

### 2 Press the [LFO FORM (WAKE UP)] button.

Transmission of the MIDI signals begins.

The MIDI signal waveform pattern switches each time the [LFO FORM (WAKE UP)] button is pressed.

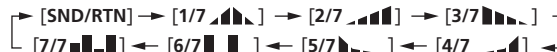

### 3 Press the [BEAT ◀, ▶] button.

Set the MIDI signal's waveform output time.

### 4 Press the [ON/OFF] button of [BEAT EFFECTS] or touch the [X-PAD].

The MIDI message for turning the effect on is sent.

- When the [LFO FORM (WAKE UP)] button is pressed and a setting from [1/7 ▲▲▲] – [7/7 ■■■] is selected, the MIDI message for the buttons and controls below can be sent even when the MIDI mode is turned off.
  - [X-PAD] (Touch ↔ Release)
  - [CUE] button of [BEAT EFFECTS]
  - [1, 2, 3, 4, MIC, CF.A, CF.B, MASTER] selector switch
  - [LEVEL/DEPTH] control
  - [ON/OFF] button of [BEAT EFFECTS]
- When the [LFO FORM (WAKE UP)] button is pressed to switch between [SND/RTN] and [MIDI LFO], BEAT EFFECT automatically turns off.
- It is not possible to switch between [SND/RTN] and [MIDI LFO] while touching the [X-PAD].

## ❖ Sending the MIDI start and MIDI stop messages

### Press the [START/STOP] button for [MIDI].

- The MIDI start and MIDI stop messages are sent alternatively each time the [START/STOP] button is pressed, regardless of whether the MIDI function is on or off.

## Operating an external MIDI sequencer

This unit outputs the operation information of buttons and controls in universal MIDI format.

This unit sends the tempo of the currently playing source (BPM information) as the MIDI timing clock. This can be used to synchronize an external MIDI sequencer with the tempo of the source.

- For the messages output by this unit, see *List of MIDI Messages* on page 21.
- External MIDI sequencers not supporting MIDI timing clocks cannot be synchronized.
- External MIDI sequencers cannot be synchronized for sources for which the BPM cannot be measured stably.
- The MIDI timing clock is output even with BPM values input manually by tapping the [TAP] button with a finger. The MIDI timing clock output range is 40 BPM to 250 BPM.

### 1 Connect the [MIDI OUT] terminal to the external MIDI sequencer's MIDI IN terminal using a commercially available MIDI cable.

### 2 Set the external MIDI sequencer's sync mode to Slave.

### 3 Press the [START/STOP] button for [MIDI].

The MIDI start message is sent.

### 4 Press [ON/OFF] in the [MIDI] section.

Transmission of the MIDI messages begin.

# Types of effects

## Types of SOUND COLOR FX effects

Effect Name	Descriptions	COLOR control
SPACE	Applies a reverberation effect to the original sound.	Turn counterclockwise: Applies the reverberation effect to the mid- and low ranges. Turn clockwise: Applies the reverberation effect to the mid- and high ranges.
DUB ECHO	Applies an echo effect, with the sound delayed slightly after the original sound output several times and gradually attenuated.	Turn counterclockwise: Applies the echo effect to the mid-range only. Turn clockwise: Applies the echo effect to the high range only.
GATE/COMP	Changes the texture of the overall sound.	Turn counterclockwise: A gate effect makes the sound tighter, with a reduced sense of volume. Turn clockwise: A compressor effect makes the sound fatter, with an increased sense of volume.
NOISE	White noise generated inside this unit is mixed in to the sound of the channel via the filter and output. <ul style="list-style-type: none"> <li>The volume can be adjusted by turning the [TRIM] controls for the respective channels. The sound quality can be adjusted by turning the [EQ/ISO (HI, MID, LOW)] controls.</li> </ul>	Turn counterclockwise: The cut-off frequency of the filter through which the white noise passes gradually decreases. Turn clockwise: The cut-off frequency of the filter through which the white noise passes gradually increases.
CRUSH	Changes the original sound to a crushed-like sound for output.	Turn counterclockwise: Increases the sound's distortion. Turn clockwise: The sound is crushed before passing through the high pass filter.
FILTER	Outputs sound that has passed through a filter.	Turn counterclockwise: Gradually decreases the low-pass filter's cutoff frequency. Turn clockwise: Gradually increases the high-pass filter's cutoff frequency.

## Types of BEAT EFFECT

### DELAY<sup>[1]</sup>

A delay sound is output once according to the beat fraction set with the [BEAT ◀, ▶] buttons.

When 1/2 beat delay sound is added, 4 beats become 8 beats.



BEAT ◀, ▶ buttons (parameter 1)	Use these to set a time delay of 1/8 – 16/1 with respect to the time of one beat of the BPM.
TIME control (parameter 2)	Use this to set the delay time. 1 to 4000 (ms)
LEVEL/DEPTH control (parameter 3)	Use this to set the balance between the original sound and the delay sound.
X-PAD (parameter 4)	Use this to set the delay time.

### ECHO<sup>[1] [2]</sup>

A delay sound is output several times and gradually attenuated according to the beat fraction set with the [BEAT ◀, ▶] buttons.

With 1/1 beat echoes, the delay sounds are faded out according to the track's tempo even after the input sound has been cut.

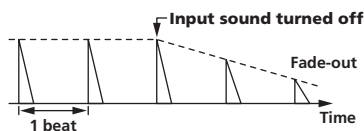

BEAT ◀, ▶ buttons (parameter 1)	Use these to set a time delay of 1/8 – 16/1 with respect to the time of one beat of the BPM.
TIME control (parameter 2)	Use this to set the delay time. 1 to 4000 (ms)
LEVEL/DEPTH control (parameter 3)	Use this to set the balance between the original sound and the echo sound.
X-PAD (parameter 4)	Use this to set the delay time.

### SPIRAL<sup>[1] [2]</sup>

This function adds a reverberation effect to the input sound. When the delay time is changed, the pitch changes simultaneously.

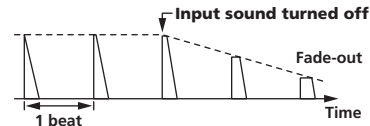

BEAT ◀, ▶ buttons (parameter 1)	Use these to set a time delay of 1/8 – 16/1 with respect to the time of one beat of the BPM.
TIME control (parameter 2)	Use this to set the delay time. 10 to 4000 (ms)
LEVEL/DEPTH control (parameter 3)	Use this to set the balance between the original sound and the effect sound and to set the quantitative parameter.
X-PAD (parameter 4)	Use this to set the delay time.

### REVERB<sup>[1] [2]</sup>

This function adds a reverberation effect to the input sound.

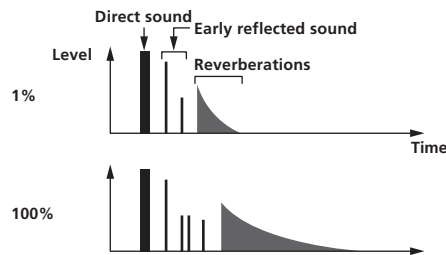

BEAT ◀, ▶ buttons (parameter 1)	Use these to set the extent of the reverberation effect, from 1 – 100 %.
TIME control (parameter 2)	Use this to set the degree of the reverb effect. 1 – 100 (%)
LEVEL/DEPTH control (parameter 3)	Sets the balance between the original sound and the effect sound.
X-PAD (parameter 4)	Sets the filter's cut-off frequency.

### TRANS<sup>[1]</sup>

The sound is cut according to the beat fraction set with the [BEAT ◀, ▶] buttons.

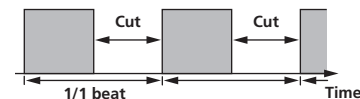

BEAT ◀, ▶ buttons (parameter 1)	Use these to set a cut time of 1/16 – 16/1 with respect to the time of one beat of the BPM.
TIME control (parameter 2)	Use this to set the effect time. 10 to 16000 (ms)
LEVEL/DEPTH control (parameter 3)	Sets the balance between the original sound and the effect sound.
X-PAD (parameter 4)	This sets the cut time.

## FILTER<sup>1</sup>

The filter's cutoff frequency changes according to the beat fraction set with the [BEAT ◀, ▶] buttons.

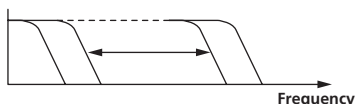

<b>BEAT</b> ◀, ▶ buttons (parameter 1)	Use these to set the cycle for moving the cut-off frequency as a time of $1/4 - 64/1$ with respect to the time of one beat of the BPM.
<b>TIME</b> control (parameter 2)	Use this to set the cycle at which the cut-off frequency is moved. <b>10 to 32000</b> (ms)
<b>LEVEL/DEPTH</b> control (parameter 3)	The further the control is turned clockwise, the more the effect is stressed.
<b>X-PAD</b> (parameter 4)	The cycle at which the cut-off frequency is moved fluctuates finely.

## FLANGER<sup>1</sup>

A 1-cycle flanger effect is produced according to the beat fraction set with the [BEAT ◀, ▶] buttons.

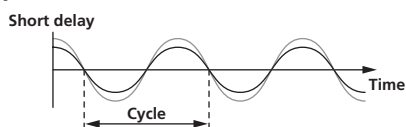

<b>BEAT</b> ◀, ▶ buttons (parameter 1)	Use these to set the $1/4 - 64/1$ effect time with respect to the time of one beat of the BPM.
<b>TIME</b> control (parameter 2)	Use this to set the cycle by which the flanger effect moves. <b>10 to 32000</b> (ms)
<b>LEVEL/DEPTH</b> control (parameter 3)	The further the control is turned clockwise, the more the effect is stressed. When turned all the way counterclockwise, only the original sound is output.
<b>X-PAD</b> (parameter 4)	The cycle at which the flanger effect is moved fluctuates finely.

## PHASER<sup>1</sup>

The phaser effect changes according to the beat fraction set with the [BEAT ◀, ▶] buttons.

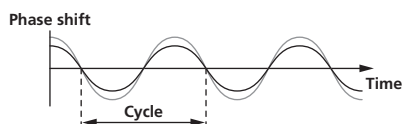

<b>BEAT</b> ◀, ▶ buttons (parameter 1)	Use these to set the cycle for moving the phaser effect as of time of $1/4 - 64/1$ with respect to the time of one beat of the BPM.
<b>TIME</b> control (parameter 2)	This sets the cycle by which the phaser effect is moved. <b>10 to 32000</b> (ms)
<b>LEVEL/DEPTH</b> control (parameter 3)	The further the control is turned clockwise, the more the effect is stressed. When turned all the way counterclockwise, only the original sound is output.
<b>X-PAD</b> (parameter 4)	The cycle at which the phaser effect is moved fluctuates finely.

## ROBOT<sup>1</sup>

The original sound is changed to a sound like one produced by a robot.

<b>BEAT</b> ◀, ▶ buttons (parameter 1)	Use these to set the degree of the effect sound, from <b>-100 - 100</b> %.
<b>TIME</b> control (parameter 2)	Use this to set the degree of the effect sound. <b>-100-100</b> (%)
<b>LEVEL/DEPTH</b> control (parameter 3)	Sets the balance between the original sound and the effect sound.
<b>X-PAD</b> (parameter 4)	This changes the degree of the effect sound.

## MELODIC<sup>1 2</sup>

The mid-range of the sound being input at the point when the [ON/OFF] button is pressed is recorded, and the recorded sound is output according to the level of the sound being input.

<b>BEAT</b> ◀, ▶ buttons (parameter 1)	This sets the way in which the recorded sound is played.
<b>TIME</b> control (parameter 2)	This sets the way in which the recorded sound is played.
<b>LEVEL/DEPTH</b> control (parameter 3)	This sets the balance between the original sound and the recorded sound.
<b>X-PAD</b> (parameter 4)	This sets the way in which the recorded sound is played.

## SLIP ROLL<sup>1 2</sup>

The sound being input at the point when the [ON/OFF] is pressed is recorded, and the recorded sound is output repeatedly according to the beat fraction set with the [BEAT ◀, ▶] buttons.

When the effect time changes, the input sound is recorded again.

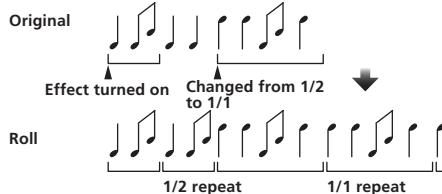

<b>BEAT</b> ◀, ▶ buttons (parameter 1)	Use these to set an effect time of $1/16 - 16/1$ with respect to the time of one beat of the BPM.
<b>TIME</b> control (parameter 2)	Use this to set the effect time. <b>10 to 4000</b> (ms)
<b>LEVEL/DEPTH</b> control (parameter 3)	Use this to set the balance between the original sound and <b>ROLL</b> .
<b>X-PAD</b> (parameter 4)	Use this to set the effect time.

## ROLL<sup>1 2</sup>

The sound being input at the point when the [ON/OFF] is pressed is recorded, and the recorded sound is output repeatedly according to the beat fraction set with the [BEAT ◀, ▶] buttons.

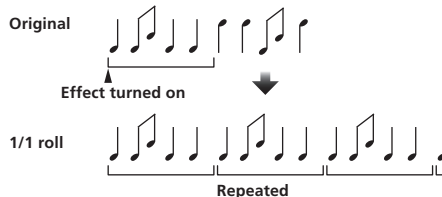

<b>BEAT</b> ◀, ▶ buttons (parameter 1)	Use these to set an effect time of $1/16 - 16/1$ with respect to the time of one beat of the BPM.
<b>TIME</b> control (parameter 2)	Use this to set the effect time. <b>10 to 4000</b> (ms)
<b>LEVEL/DEPTH</b> control (parameter 3)	Use this to set the balance between the original sound and <b>ROLL</b> .
<b>X-PAD</b> (parameter 4)	Use this to set the effect time.

## REV ROLL<sup>1 2</sup>

The sound being input at the point when the [ON/OFF] button is pressed is recorded, and the recorded sound is reversed then output repeatedly according to the beat fraction set with the [BEAT ◀, ▶] buttons.

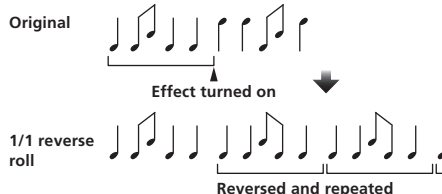

<b>BEAT</b> ◀, ▶ buttons (parameter 1)	Use these to set an effect time of $1/16 - 16/1$ with respect to the time of one beat of the BPM.
<b>TIME</b> control (parameter 2)	Use this to set the effect time. <b>10 to 4000</b> (ms)
<b>LEVEL/DEPTH</b> control (parameter 3)	Use this to set the balance between the original sound and <b>ROLL</b> .
<b>X-PAD</b> (parameter 4)	Use this to set the effect time.

## SND/RTN (MIDI LFO)

Connect an external effector, etc., here.

By pressing the **[LFO FORM (WAKE UP)]** button, MIDI-compatible software and devices can be controlled using MIDI signals.

### ❖ SND/RTN<sup>1)</sup>

Connect an external effector, etc., here.

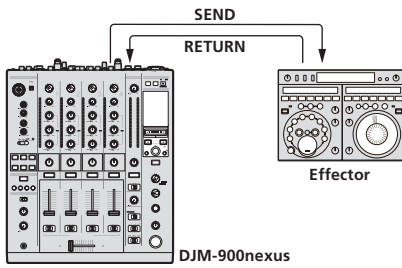

<b>BEAT</b> ◀ ▶ buttons (parameter 1)	—
<b>TIME</b> control (parameter 2)	—
<b>LEVEL/DEPTH</b> control (parameter 3)	This adjusts the sound level input to the <b>[RETURN]</b> terminal.
<b>X-PAD</b> (parameter 4)	—

### ❖ MIDI LFO

The MIDI signal (0 – 127) waveform is changed according to the track's tempo. The MIDI signal waveform pattern switches each time the **[LFO FORM (WAKE UP)]** button is pressed.



<b>BEAT</b> ◀ ▶ buttons (parameter 1)	Use these to set a waveform output time of <b>1/4 – 64/1</b> with respect to one beat of the BPM.
<b>TIME</b> control (parameter 2)	Use this to set the waveform output time.
<b>LEVEL/DEPTH</b> control (parameter 3)	—
<b>X-PAD</b> (parameter 4)	This changes the MIDI signal's waveform pattern.

- When **[MIDI LFO]** is selected, the sound of the external effector connected to the **[RETURN]** terminal is not input.

<sup>1)</sup> If the sound of the channel you want to monitor is not output from the **[MASTER]** channel when **[CF.A]**, **[CF.B]** or **[MASTER]** is selected with the **[1, 2, 3, 4, MIC, CF.A, CF.B, MASTER]** selector switch, the effect sound cannot be monitored even by pressing the **[CUE]** button for **[BEAT EFFECTS]**.

<sup>2)</sup> If the effect is off, the effect sound cannot be monitored even by pressing the **[CUE]** button for **[BEAT EFFECTS]**.

# List of MIDI Messages

Category	SW Name	SW Type	MIDI Messages						Trigger/Toggle	Notes
			MSB			LSB				
CH1	TRIM	VR	Bn	01	dd	—	—	—	—	0-127
	HI	VR	Bn	02	dd	—	—	—	—	0-127
	MID	VR	Bn	03	dd	—	—	—	—	0-127
	LOW	VR	Bn	04	dd	—	—	—	—	0-127
	COLOR	VR	Bn	05	dd	—	—	—	—	0-127
	CUE	BTN	Bn	46	dd	—	—	—	Trigger/Toggle	OFF=0, ON=127
	Channel fader	VR	Bn	11	MSB	—	—	—	—	0-127
	CROSS FADER ASSIGN	SW	Bn	41	dd	—	—	—	—	0, 64, 127
CH2	TRIM	VR	Bn	06	dd	—	—	—	—	0-127
	HI	VR	Bn	07	dd	—	—	—	—	0-127
	MID	VR	Bn	08	dd	—	—	—	—	0-127
	LOW	VR	Bn	09	dd	—	—	—	—	0-127
	COLOR	VR	Bn	0A	dd	—	—	—	—	0-127
	CUE	BTN	Bn	47	dd	—	—	—	Trigger/Toggle	OFF=0, ON=127
	Channel fader	VR	Bn	12	MSB	—	—	—	—	0-127
	CROSS FADER ASSIGN	SW	Bn	42	dd	—	—	—	—	0, 64, 127
CH3	TRIM	VR	Bn	0C	dd	—	—	—	—	0-127
	HI	VR	Bn	0E	dd	—	—	—	—	0-127
	MID	VR	Bn	0F	dd	—	—	—	—	0-127
	LOW	VR	Bn	15	dd	—	—	—	—	0-127
	COLOR	VR	Bn	16	dd	—	—	—	—	0-127
	CUE	BTN	Bn	48	dd	—	—	—	Trigger/Toggle	OFF=0, ON=127
	Channel fader	VR	Bn	13	MSB	—	—	—	—	0-127
	CROSS FADER ASSIGN	SW	Bn	43	dd	—	—	—	—	0, 64, 127
CH4	TRIM	VR	Bn	50	dd	—	—	—	—	0-127
	HI	VR	Bn	51	dd	—	—	—	—	0-127
	MID	VR	Bn	5C	dd	—	—	—	—	0-127
	LOW	VR	Bn	52	dd	—	—	—	—	0-127
	COLOR	VR	Bn	53	dd	—	—	—	—	0-127
	CUE	BTN	Bn	49	dd	—	—	—	Trigger/Toggle	OFF=0, ON=127
	Channel fader	VR	Bn	14	MSB	—	—	—	—	0-127
	CROSS FADER ASSIGN	SW	Bn	44	dd	—	—	—	—	0, 64, 127
Crossfader	Crossfader	VR	Bn	0B	MSB	—	—	—	—	0-127
Fader curve	CH FADER 	SW	Bn	5E	dd	—	—	—	—	0, 64, 127
	CROSS FADER 	SW	Bn	5F	dd	—	—	—	—	0, 64, 127
Master	MASTER LEVEL	VR	Bn	18	dd	—	—	—	—	0-127
	BALANCE	VR	Bn	17	dd	—	—	—	—	0-127
	CUE	BTN	Bn	4A	dd	—	—	—	Trigger/Toggle	OFF=0, ON=127
	EQ CURVE (ISOLATOR, EQ)	SW	Bn	21	dd	—	—	—	—	0, 127
BOOTH MONI-TOR	BOOTH MONITOR	VR	Bn	19	dd	—	—	—	—	0-127
LINK	CUE	BTN	Bn	73	dd	—	—	—	Trigger/Toggle	OFF=0, ON=127

Category	SW Name	SW Type	MIDI Messages						Trigger/Toggle	Notes	
			MSB			LSB					
BEAT EFFECTS	◀	BTN	Bn	4C	MSB	—	—	—	Trigger/Toggle	OFF=0, ON=127	
	▶	BTN	Bn	4D	—	—	—	—	Trigger/Toggle	OFF=0, ON=127	
	AUTO/TAP	BTN	Bn	45	dd	—	—	—	Trigger/Toggle	OFF=0, ON=127	
	TAP	BTN	Bn	4E	dd	—	—	—	Trigger only	OFF=0, ON=127	
	CUE	BTN	Bn	4B	dd	—	—	—	Trigger/Toggle	OFF=0, ON=127	
	EFFECT SELECT	DELAY	SW	Bn	2A	dd	—	—	—	[2]	OFF=0, ON=127
		ECHO	SW	Bn	37	dd	—	—	—	[2]	OFF=0, ON=127
		SPIRAL	SW	Bn	2B	dd	—	—	—	[2]	OFF=0, ON=127
		REVERB	SW	Bn	36	dd	—	—	—	[2]	OFF=0, ON=127
		TRANS	SW	Bn	35	dd	—	—	—	[2]	OFF=0, ON=127
		FILTER	SW	Bn	3B	dd	—	—	—	[2]	OFF=0, ON=127
		FLANGER	SW	Bn	32	dd	—	—	—	[2]	OFF=0, ON=127
		PHASER	SW	Bn	39	dd	—	—	—	[2]	OFF=0, ON=127
		ROBOT	SW	Bn	33	dd	—	—	—	[2]	OFF=0, ON=127
		MELODIC	SW	Bn	3D	dd	—	—	—	[2]	OFF=0, ON=127
		SLIP ROLL	SW	Bn	3A	dd	—	—	—	[2]	OFF=0, ON=127
		ROLL	SW	Bn	2E	dd	—	—	—	[2]	OFF=0, ON=127
	REV ROLL	SW	Bn	2F	dd	—	—	—	[2]	OFF=0, ON=127	
	SND/RTN (MIDI LFO)	SW	Bn	3E	dd	—	—	—	[2]	OFF=0, ON=127	
	CH SELECT	CH1	SW	Bn	22	dd	—	—	—	[2]	OFF=0, ON=127
		CH2	SW	Bn	23	dd	—	—	—	[2]	OFF=0, ON=127
		CH3	SW	Bn	24	dd	—	—	—	[2]	OFF=0, ON=127
		CH4	SW	Bn	25	dd	—	—	—	[2]	OFF=0, ON=127
		MIC	SW	Bn	26	dd	—	—	—	[2]	OFF=0, ON=127
		CF.A	SW	Bn	27	dd	—	—	—	[2]	OFF=0, ON=127
		CF.B	SW	Bn	28	dd	—	—	—	[2]	OFF=0, ON=127
		MASTER	SW	Bn	29	dd	—	—	—	[2]	OFF=0, ON=127
	MIDI LFO	VR	Bn	76	dd	—	—	—	—	0-127	
	QUANTIZE	BTN	9n	76	dd	—	—	—	Trigger/Toggle	—	
TIME	SW	Bn	0D	MSB	Bn	2D	LSB	—	TIME value (When <b>FLANGER</b> , <b>PHASER</b> or <b>FILTER</b> is selected, the value is halved. When a negative value is selected, it is set to a positive value.)		
LEVEL/DEPTH	VR	Bn	5B	dd	—	—	—	—	0-127		
X-PAD	VR	Bn	74	dd	—	—	—	—	Sends the [X-PAD] position information.		
ON/OFF X-PAD (touch) • When an effect other than [SND/RTN (MIDI LFO)] is selected at BEAT EFFECT	BTN	Bn	72	dd	—	—	—	[2]	OFF=0, ON=127		
ON/OFF X-PAD (touch) • When [SND/RTN (MIDI LFO)] is selected at BEAT EFFECT	BTN	Bn	40	dd	—	—	—	[2]	OFF=0, ON=127		
MIC	HI	VR	Bn	1E	dd	—	—	—	—	0-127	
	LOW	VR	Bn	1F	dd	—	—	—	—	0-127	
SOUND COLOR FX	NOISE	BTN	Bn	55	dd	—	—	—	Trigger/Toggle <sup>[1]</sup>	OFF=0, ON=127	
	SPACE	BTN	Bn	69	dd	—	—	—	Trigger/Toggle <sup>[1]</sup>	OFF=0, ON=127	
	GATE/COMP	BTN	Bn	6A	dd	—	—	—	Trigger/Toggle <sup>[1]</sup>	OFF=0, ON=127	
	DUB ECHO	BTN	Bn	6B	dd	—	—	—	Trigger/Toggle <sup>[1]</sup>	OFF=0, ON=127	
	CRUSH	BTN	Bn	56	dd	—	—	—	Trigger/Toggle <sup>[1]</sup>	OFF=0, ON=127	
	FILTER	BTN	Bn	57	dd	—	—	—	Trigger/Toggle <sup>[1]</sup>	OFF=0, ON=127	
Fader Start	Fader Start 1	BTN	Bn	58	dd	—	—	—	Trigger/Toggle	OFF=0, ON=127	
	Fader Start 2	BTN	Bn	59	dd	—	—	—	Trigger/Toggle	OFF=0, ON=127	
	Fader Start 3	BTN	Bn	5A	dd	—	—	—	Trigger/Toggle	OFF=0, ON=127	
	Fader Start 4	BTN	Bn	5D	dd	—	—	—	Trigger/Toggle	OFF=0, ON=127	
HEADPHONES	MIXING	VR	Bn	1B	dd	—	—	—	—	0-127	
	LEVEL	VR	Bn	1A	dd	—	—	—	—	0-127	
	Timing Clock	—	F8	—	—	—	—	—	—		
Fader Start	Fader Start 1		9n	66	dd	—	—	—	—	BACK CUE = 0, PLAY = 127	
	Fader Start 2		9n	67	dd	—	—	—	—	BACK CUE = 0, PLAY = 127	
	Fader Start 3		9n	68	dd	—	—	—	—	BACK CUE = 0, PLAY = 127	
	Fader Start 4		9n	69	dd	—	—	—	—	BACK CUE = 0, PLAY = 127	
MIDI	START	BTN	FA	—	—	—	—	—	—	—	
	STOP	BTN	FC	—	—	—	—	—	—	—	

[1] When turning one button on switches another button from on to off, MIDI on and off messages are sent from the two buttons.

When there is no button that switches off, only the MIDI on message is sent from the button that was pressed.

[2] When switched from one position to another position, the MIDI ON and OFF signals are sent respectively from both positions.

• When the [START/STOP] button is pressed for over 1 second, MIDI messages corresponding to the positions of the buttons, faders and controls are sent in a bundle (Snapshot). The MIDI Snapshot sends all MIDI messages other than MIDI start and MIDI stop.

# Changing the settings

## 1 Press the [ON/OFF (UTILITY)] button for over 1 second.

The [USER SETUP] mode setting screen is displayed.

- To display the [CLUB SETUP] mode setting screen, first turn this unit's power off, then press the [POWER] button while pressing the [ON/OFF (UTILITY)] button.

## 2 Press the [BEAT ◀, ▶] button.

Select the setting item.

## 3 Press the [TAP] button.

The screen switches to the setting item's setting value change screen.

## 4 Press the [BEAT ◀, ▶] button.

Change the setting value.

## 5 Press the [TAP] button.

Enter the setting value.

The previous screen reappears.

- To return to the previous screen without changing the settings, press the [QUANTIZE] button.

## 6 Press the [ON/OFF (UTILITY)] button.

Close the [USER SETUP] mode setting screen.

- To close the [CLUB SETUP] mode setting screen, press the [POWER] button to turn this unit's power off.

## About the auto standby function

When [Auto Standby] is set to [ON], the standby mode is set automatically if 4 hours pass with all of the conditions shown below met.

- That none of this unit's buttons or controls are operated.
- That no audio signals of  $-10$  dB or greater are input to this unit's input terminals.
- That no PRO DJ LINK connections are made.
- When the [LFO FORM (WAKE UP)] button is pressed, the standby mode is canceled.
- This unit is shipped with the auto standby function turned on. If you do not want to use the auto standby function, set [Auto Standby] to [OFF].

## About the talk over function

The talk over function has the two modes described below.

- [ADV] (advanced talk over): The mid-range only of the sound of channels other than the [MIC] channel is attenuated according to the [Talk Over LEVEL] setting value and output.

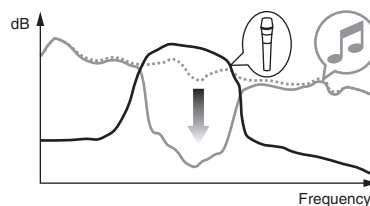

- [NOR] (normal talk over): The sound of channels other than the [MIC] channel is attenuated according to the [Talk Over LEVEL] setting value and output.

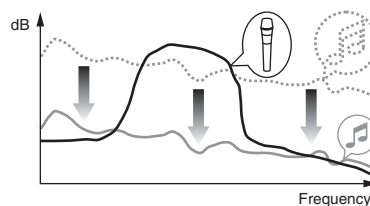

## Setting preferences

\*: Setting upon purchase

Mode	Options settings	Screen display	Setting value	Descriptions
USER SETUP	Fader Start	F.S.	ON, OFF*	Turns the fader start function on and off for all DJ players connected to the [LINK] terminals.
	MIDI CH	MIDI CH	1* to 16	Sets the MIDI channel.
	MIDI Button Type	MIDI BT	TGL*, TRG	Selects the MIDI signal transmission mode, [TGL (TOGGLE)] or [TRG (TRIGGER)].
	Talk Over Mode	TLK MOD	ADV*, NOR	Selects the talk over function's mode, [ADV (ADVANCED)] or [NOR (NORMAL)].
	Talk Over LEVEL	TLK LVL	-6 dB, -12 dB, -18 dB*, -24 dB	Sets the talk over function's sound attenuation level.
CLUB SETUP	Digital Master Out Level	DOUT LV	-19 dB*, -15 dB, -10 dB, -5 dB	Sets the maximum level of the sound output from the [DIGITAL MASTER OUT] terminals. [1]
	Digital Master Out Sampling Rate	DOUT FS	48 kHz, 96 kHz*	Sets the digital signal's sampling rate.
	MASTER ATT.	MST ATT	-6 dB, -3 dB, 0 dB*	Sets the attenuation level of the sound output from the [MASTER1] and [MASTER2] terminals.
	Auto Standby	AUTOSTB	ON*, OFF	Turns the auto standby function on and off.
	Mic Output To Booth Monitor	MIC BTH	ON*, OFF	Sets whether or not to output the microphone's audio signals from [BOOTH] terminals.
	PC UTILITY	PC UTLY	ON*, OFF	Sets whether or not to launch the computer's setting utility software automatically when a USB cable is connected.
	Factory Reset	INITIAL	YES, NO*	Restores all the settings to their factory defaults.

[1]: Note that the output sound may be distorted even if the master level indicator does not light up to the very top.

# Additional information

## Troubleshooting

- Incorrect operation is often mistaken for trouble or malfunction. If you think that there is something wrong with this component, check the points below. Sometimes the trouble may lie in another component. Inspect the other components and electrical appliances being used. If the trouble cannot be rectified after checking the items below, ask your nearest Pioneer authorized service center or your dealer to carry out repair work.
- The player may not operate properly due to static electricity or other external influences. In such cases, normal operation may be restored by unplugging the power cord then plugging it back in.

Problem	Check	Remedy
The power is not turned on.	Is the power cord properly connected?	Plug in the power cord to an AC outlet.
No sound or small sound.	Is the <b>[DIGITAL, CD/LINE, PHONO, LINE, USB */*]</b> selector switch set to the proper position?	Turn the <b>[DIGITAL, CD/LINE, PHONO, LINE, USB */*]</b> selector switch to switch to the channel's input source. (page 14)
	Are the connection cables properly connected?	Connect the connection cables properly. (page 8)
	Are the terminals and plugs dirty?	Clean the terminals and plugs before making connections.
	Is <b>[MASTER ATT.]</b> set to <b>[-6 dB]</b> , etc.?	At the <b>[USER SETUP]</b> screen, switch <b>[MASTER ATT.]</b> . (page 23)
Digital sound cannot be output.	Is the digital audio output's sampling frequency (fs) suited for the specifications of the connected device?	On the <b>[CLUB SETUP]</b> screen, set <b>[Digital Master Out Sampling Rate]</b> according to the specifications of the connected equipment. (page 23)
Distorted sound.	Is the sound level output from the <b>[MASTER]</b> channel appropriately set?	Adjust the <b>[MASTER LEVEL]</b> control so that the master channel level indicator lights at around <b>[0 dB]</b> at the peak level. (page 14) Set <b>[MASTER ATT.]</b> to <b>[-3 dB]</b> or <b>[-6 dB]</b> . (page 23)
	Is the level of audio input to each channel properly set?	Adjust the <b>[TRIM]</b> control so that the channel level indicator lights at about <b>[0 dB]</b> at the peak level. (page 14)
Can't crossfade.	Are the <b>CROSS FADER ASSIGN (A, THRU, B)</b> selector switches properly set?	Set the <b>[CROSS FADER ASSIGN (A, THRU, B)]</b> selector switches for the different channels properly. (page 14)
Can't fader start a DJ player.	Is <b>[FADER START]</b> set to <b>[OFF]</b> ?	At the <b>[USER SETUP]</b> screen, set <b>[FADER START]</b> to <b>[ON]</b> . (page 23)
	Is the DJ player properly connected to the <b>[LINK]</b> terminal?	Connect the DJ player to the <b>[LINK]</b> terminal properly using a LAN cable. (page 8)
	Are the audio cables properly connected?	Connect this unit's audio input terminals and the DJ player's audio output terminals by audio cable. (page 8)
	Is the DJ player's player number properly set?	Set the DJ player's player number to the same number as the channel to which the audio cable is connected.
<b>[BEAT EFFECTS]</b> does not work.	Is the <b>[1, 2, 3, 4, MIC, CF.A, CF.B, MASTER]</b> selector switch properly set?	Turn the <b>[1, 2, 3, 4, MIC, CF.A, CF.B, MASTER]</b> selector switch to select the channel to which you want to apply the effect.
<b>[SOUND COLOR FX]</b> does not work.	Is the <b>[COLOR]</b> control set to an appropriate position?	Turn the <b>[COLOR]</b> control clockwise or counterclockwise. (page 15)
Can't use an external effector.	Is the <b>[ON/OFF]</b> button for <b>[BEAT EFFECTS]</b> set to <b>[ON]</b> ?	Press the <b>[ON/OFF]</b> button for <b>[BEAT EFFECTS]</b> to set <b>[SND/RTN]</b> to <b>[ON]</b> . (page 16)
	Is the external effector properly connected to the <b>[SEND]</b> or <b>[RETURN]</b> terminal?	Connect the external effector to the <b>[SEND]</b> and <b>[RETURN]</b> terminals. (page 8)
Distorted sound from an external effector.	Is the external effector's audio output level set to an appropriate level?	Adjust the external effector's audio output level.
Tempo <b>(BPM)</b> cannot be measured or measurement value of tempo <b>(BPM)</b> is implausible.	Is the audio input level too high or too low?	Adjust the <b>[TRIM]</b> control so that the channel level indicator lights at about <b>[0 dB]</b> at the peak level. (page 14) For some tracks, it may not be possible to measure the tempo <b>(BPM)</b> . Use the <b>[TAP]</b> button to input the tempo manually. (page 16)
Measured tempo <b>(BPM)</b> differs from tempo indicated on CD.	—	The values may differ slightly due to the different ways in which the <b>BPM</b> is measured. There is no need to make any corrections.
MIDI sequencer does not synchronize.	Is the MIDI sequencer's sync mode set to Slave?	Set the MIDI sequencer's sync mode to Slave.
	Does the MIDI sequencer you are using support MIDI timing clocks?	MIDI sequencers not supporting MIDI timing clocks cannot be synchronized.
MIDI control does not work.	Is the MIDI channel turned on?	Press the <b>[ON/OFF]</b> button for <b>[MIDI]</b> . ( <i>Operating DJ software using the MIDI function on page 17</i> )
	Are the MIDI settings properly set?	To operate DJ software with this unit, this unit's MIDI messages must be assigned to the DJ software you are using. For instructions on assigning messages, see your DJ software's operating instructions.
This unit is not recognized after it has been connected to a computer. USB indicator is off or flashing.	Is the driver software properly installed on your computer?	Install the driver software. If it is already installed, reinstall it. (page 9)
Sound of a computer cannot be output from this unit.	Are this unit and computer properly connected?	Connect this unit and computer using a USB cable. (page 9)
	Are the audio output device settings properly set?	Select this unit with the audio output device settings. For instructions on making settings for your application, see your application's operating instructions.
	Is the <b>[DIGITAL, CD/LINE, PHONO, LINE, USB */*]</b> selector switch set to the proper position?	Set the <b>[DIGITAL, CD/LINE, PHONO, LINE, USB */*]</b> selector switch to the <b>[USB */*]</b> position. (page 14)
Effect sound cannot be monitored even when the <b>[CUE]</b> button for <b>[BEAT EFFECTS]</b> is pressed.	—	The circuit that generates the echo for the <b>[ECHO]</b> , <b>[REVERB]</b> , <b>[ROLL]</b> , <b>[SLIP ROLL]</b> and <b>[REV ROLL]</b> effect sounds is positioned after the effect circuit, so the effect sound cannot be monitored. This is not a malfunction.
Sound is distorted when an analog player is connected to this unit's <b>[PHONO]</b> terminals. Or, lighting of the channel level indicator does not change even when the <b>[TRIM]</b> control is turned.	Have you connected an analog player with a built-in phono equalizer?	For analog players with built-in phono equalizers, connect the player to the <b>[CD/LINE]</b> or <b>[LINE]</b> terminals. (page 8) If the analog player with built-in phono equalizer has a <b>PHONO/LINE</b> selector switch, switch it to <b>PHONO</b> .
	Is an audio interface for computers connected between the analog player and this unit?	If the audio interface for computers has a line level output, connect it to the <b>[CD/LINE]</b> or <b>[LINE]</b> terminal. (page 8) If the analog player has a <b>PHONO/LINE</b> selector switch, switch it to <b>PHONO</b> .



# Block Diagram

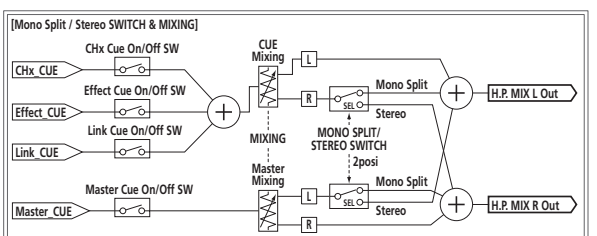
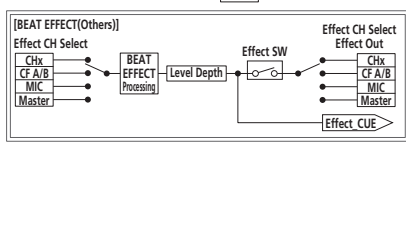
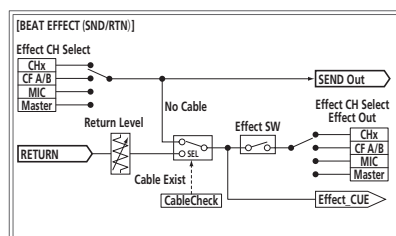
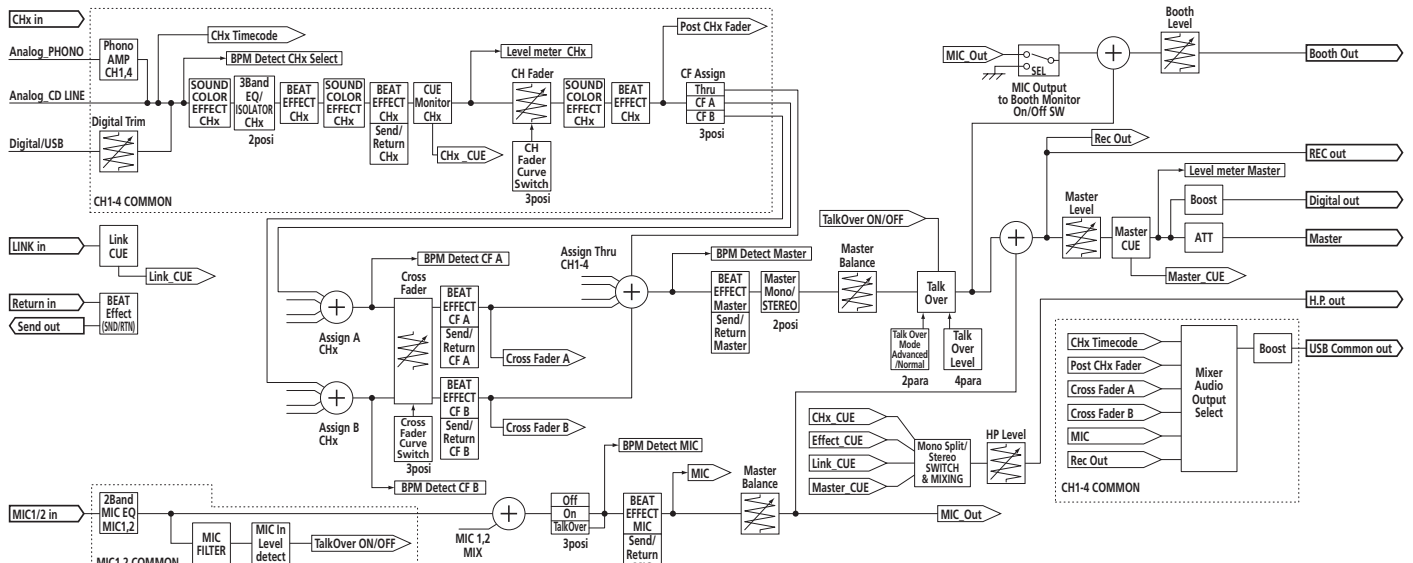
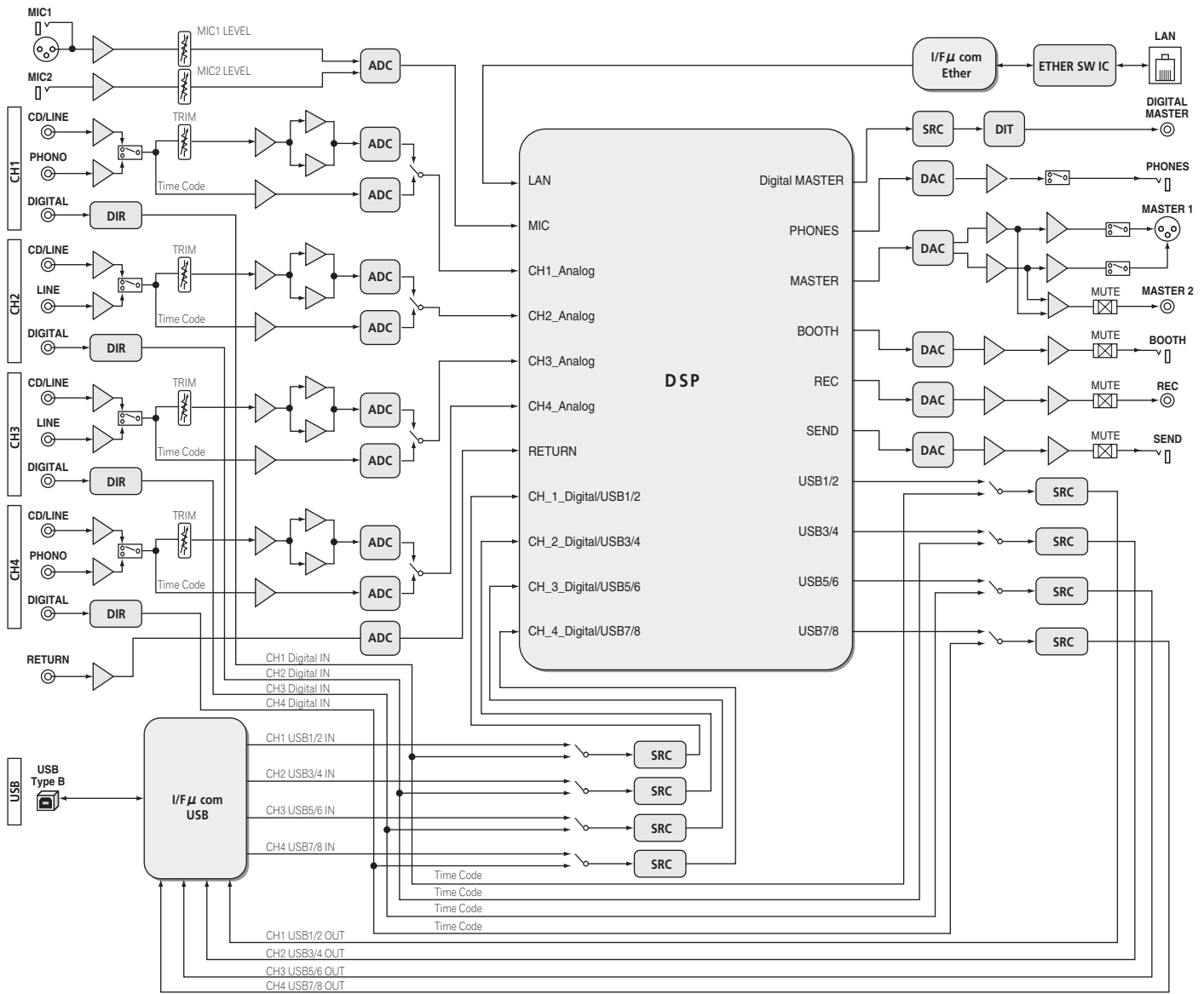

Additional information

## Disclaimer

- Pioneer and rekordbox are trademarks or registered trademarks of the Pioneer Corporation.
  - Microsoft®, Windows Vista®, and Windows® are either registered trademarks or trademarks of Microsoft Corporation in the United States and/or other countries.
  - Apple, Macintosh and Mac OS are trademarks of Apple Inc., registered in the U.S. and other countries.
  - ASIO is a trademark of Steinberg Media Technologies GmbH.
- The names of companies and products mentioned herein are the trademarks of their respective owners.

## Specifications

### General

Power requirements .....	AC 120 V, 60 Hz
Power consumption.....	42 W
Power consumption (standby) .....	0.4 W
Main unit weight .....	7.1 kg (15.7 lb)
Max. dimensions.....	331 mm (W) × 107.9 mm (H) × 409 mm (D) (13 in. (W) × 4.2 in. (H) × 16.1 in. (D))
Tolerable operating temperature .....	+5 °C to +35 °C (+41 °F to +95 °F)
Tolerable operating humidity .....	.5 % to 85 % (no condensation)

### Audio Section

Sampling rate .....	.96 kHz
MASTER D/A converter .....	32 bits
Other A/D and D/A converters .....	24 bits
Frequency characteristic	
<b>CD/LINE</b> .....	20 Hz to 20 kHz
S/N ratio (rated output)	
<b>PHONO</b> .....	88 dB
<b>CD/LINE</b> .....	105 dB
<b>MIC1, MIC2</b> .....	84 dB
Total harmonic distortion ( <b>CD/LINE — MASTER1</b> ) .....	0.005 %
Standard input level / Input impedance	
<b>PHONO</b> .....	-52 dBu/47 kΩ
<b>CD/LINE</b> .....	-12 dBu/47 kΩ
<b>MIC1</b> .....	-52 dBu/8 kΩ
<b>MIC2</b> .....	-52 dBu/12 kΩ
<b>RETURN</b> .....	-12 dBu/47 kΩ
Standard output level / Load impedance / Output impedance	
<b>MASTER1</b> .....	+8 dBu/10 kΩ/5 Ω or lower
<b>MASTER2</b> .....	+2 dBu/10 kΩ/22 Ω or lower
<b>REC OUT</b> .....	-8 dBu/10 kΩ/22 Ω or lower
<b>BOOTH</b> .....	+8 dBu/10 kΩ/1 kΩ or lower
<b>SEND</b> .....	-12 dBu/10 kΩ/1 kΩ or lower
<b>PHONES</b> .....	+8.5 dBu/32 Ω/1 Ω or lower
Rated output level / Load impedance	
<b>MASTER1</b> .....	+26 dBu/10 kΩ
<b>MASTER2</b> .....	+22 dBu/10 kΩ
Crosstalk ( <b>LINE</b> ) .....	82 dB
Channel equalizer characteristic	
<b>HI</b> .....	-26 dB to +6 dB (13 kHz)
<b>MID</b> .....	-26 dB to +6 dB (1 kHz)
<b>LOW</b> .....	-26 dB to +6 dB (70 Hz)
Microphone equalizer characteristic	
<b>HI</b> .....	-12 dB to +12 dB (10 kHz)
<b>LOW</b> .....	-12 dB to +12 dB (100 Hz)

### Input / Output terminals

<b>PHONO</b> input terminal	
RCA pin jack .....	2 sets
<b>CD/LINE</b> input terminal	
RCA pin jacks .....	4 sets
<b>LINE</b> input terminal	
RCA pin jack .....	2 sets
<b>MIC1</b> input terminal	
XLR connector/phone jack (Ø 6.3 mm).....	1 set
<b>MIC2</b> input terminal	
Phone jack (Ø 6.3 mm) .....	1 set
<b>RETURN</b> Input terminals	
Phone jack (Ø 6.3 mm) .....	1 set
<b>DIGITAL IN</b> coaxial input terminal	
RCA pin jacks .....	4 sets
<b>MASTER</b> output terminal	
XLR connector .....	1 set
RCA pin jacks .....	1 set
<b>BOOTH</b> output terminal	
Phone jack (Ø 6.3 mm) .....	1 set
<b>REC OUT</b> output terminal	
RCA pin jacks .....	1 set
<b>SEND</b> output terminal	
Phone jack (Ø 6.3 mm) .....	1 set

<b>DIGITAL MASTER OUT</b> coaxial output terminal	
RCA pin jacks .....	1 set
<b>MIDI OUT</b> terminal	
5P DIN .....	1 set
<b>PHONES</b> output terminal	
Stereo phone jack (Ø 6.3 mm).....	1 set
<b>USB</b> terminal	
B type .....	1 set
<b>LINK</b> terminal	
LAN terminal (100Base-TX).....	1 set

- The specifications and design of this product are subject to change without notice.



# Pioneer Electronics(USA) Inc.

## Limited Warranty

### WARRANTY PERIOD

For the period specified below from the date of original purchase (the warranty period), Pioneer Electronics(USA) Inc. (Pioneer) warrants that the products described below, if purchased directly from Pioneer or from an authorized Pioneer dealer or distributor in the United States and installed and operated according to operating instructions enclosed with the unit, will be repaired or replaced with a unit of comparable value, at the option of Pioneer, without charge to you for parts or labor for actual repair work if such products fail to function properly under normal use due to a manufacturing defect. Parts supplied under this warranty may be new or rebuilt at the option of Pioneer.

PRODUCTS COVERED	MODEL PREFIX	WARRANTY PERIOD	
		Parts	Labor
DJ Compact Disc Player	CDJ, CMX .....	1 YEAR	1 YEAR
DJ DVD Player	DVJ .....	1 YEAR	1 YEAR
Digital Media Player	DMP .....	1 YEAR	1 YEAR
DJ Mixer	DJM .....	1 YEAR	1 YEAR
DJ Effector	EFX .....	1 YEAR	1 YEAR
Video Switcher	VSW .....	1 YEAR	1 YEAR

This warranty covers the product during the warranty period whether in the possession of the original owner or any subsequent owner.

### WHAT'S NOT COVERED

This warranty does not cover the A-B Cross Fader in the DJ Mixer (model prefix DJM). This warranty does not cover any appearance item, any damage to the product resulting from alterations, modifications not authorized in writing by Pioneer, accident, misuse or abuse, damage due to lightning or to power surges or personal injury due to excessive sound pressure levels. This warranty does not cover the cost of parts or labor which would be otherwise provided without charge under this warranty, obtained from any source other than a Pioneer Authorized Service Company or other designated location. This warranty does not cover defects or damage caused by the use of unauthorized parts or labor, or from improper maintenance.

**PRODUCTS WITH ALTERED, DEFACED OR REMOVED SERIAL NUMBERS SHALL VOID THIS WARRANTY.**

### YOUR RIGHTS

**SOME STATES DO NOT ALLOW THE EXCLUSION OR LIMITATION OF INCIDENTAL OR CONSEQUENTIAL DAMAGES, SO THE FOLLOWING LIMITATIONS OR EXCLUSIONS MAY NOT APPLY TO YOU.**

**THE ABOVE WARRANTIES ARE IN LIEU OF AND EXCLUDE ALL OTHER WARRANTIES, EXPRESSED OR IMPLIED, INCLUDING WITHOUT LIMITATION IMPLIED WARRANTIES OF MERCHANTABILITY AND FITNESS FOR ANY PARTICULAR PURPOSE. IN NO EVENT SHALL PIONEER BE LIABLE FOR INCIDENTAL OR CONSEQUENTIAL DAMAGES ARISING OUT OF LOSS OF USE OR CLAIMS ASSERTED ON THE BASIS OF TORT (INCLUDING NEGLIGENCE), CONTRACT, OR OTHERWISE.**

### TO OBTAIN SERVICE

Pioneer has appointed a number of Authorized Industrial Service Companies throughout the U.S.A. should your product ever require service. To receive warranty service you will need to present your sales receipt or, if rented, your rental contract showing place and date of original purchase transaction.

Should it become necessary to ship the unit, you will need to package the product and send it, transportation prepaid, to an Authorized Service Company in the U.S.A. Carefully package the product using adequate padding material to prevent damage in transit. The original container is ideal for this purpose. Include in the package your name, address, telephone number where you can be reached during business hours, a copy of your sales receipt, and a detailed description of the problem.

To find the name and address of the nearest Pioneer Authorized service location, to obtain warranty service or for additional information about this warranty, please call or write:

PIONEER ELECTRONICS(USA) INC.  
CUSTOMER SUPPORT DIVISION  
P.O. BOX 1760  
LONG BEACH, CALIFORNIA 90801-1760  
1-800-872-4159

**DO NOT RETURN ANY PRODUCT TO ABOVE ADDRESS. IT IS NOT A SERVICE LOCATION.**

**TO ORDER REPLACEMENT PARTS CALL 800-228-7221**

RECORD THE PLACE AND DATE OF PURCHASE FOR FUTURE REFERENCE

Model No. \_\_\_\_\_ Serial No. \_\_\_\_\_ Purchase Date \_\_\_\_\_

Purchased From \_\_\_\_\_

KEEP THIS INFORMATION AND YOUR SALES RECEIPT IN A SAFE PLACE

To register your product, find the nearest authorized service location, to purchase replacement parts, operating instructions, or accessories, please go to one of following URLs :

Pour enregistrer votre produit, trouver le service après-vente agréé le plus proche et pour acheter des pièces de rechange, des modes d'emploi ou des accessoires, reportez-vous aux URL suivantes :

**In the USA/Aux Etats-Unis**

<http://www.pioneerelectronics.com>

**In Canada/Aux Canada**

<http://www.pioneerelectronics.ca>

S018\_B1\_EnFr

Published by Pioneer Corporation.  
Copyright © 2010 Pioneer Corporation.  
All rights reserved.

---

**PIONEER CORPORATION**

1-1, Shin-ogura, Saiwai-ku, Kawasaki-shi, Kanagawa 212-0031, Japan

**PIONEER ELECTRONICS (USA) INC.**

P.O. BOX 1540, Long Beach, California 90801-1540, U.S.A. TEL: (800) 421-1404

**PIONEER ELECTRONICS OF CANADA, INC.**

300 Allstate Parkway, Markham, Ontario L3R 0P2, Canada TEL: 1-877-283-5901, 905-479-4411

K002\_PSV\_CU

Printed in

<DRB1542-B>

